

The 3D Visualization of E_8 using an H_4 Folding Matrix

J Gregory Moxness*

TheoryOfEverything.org

(Dated: Original \Rightarrow November 1, 2014, Current \Rightarrow December 19, 2014)

This paper will present various techniques for visualizing a split real even E_8 representation in 2 and 3 dimensions using an E_8 to H_4 folding matrix. This matrix is shown to be useful in providing direct relationships between E_8 and the lower dimensional Dynkin and Coxeter-Dynkin geometries contained within it, geometries that are visualized in the form of real and virtual 3 dimensional objects. A direct linkage between E_8 , the folding matrix, fundamental physics particles in an extended Standard Model GraviGUT, quaternions, and octonions is introduced, and its importance is investigated and described.

PACS numbers: 02.20.-a, 61.44.Br, 04.50.-h, 04.60.Cf

Keywords: Coxeter groups, E_8 , root systems, particle physics, string theory

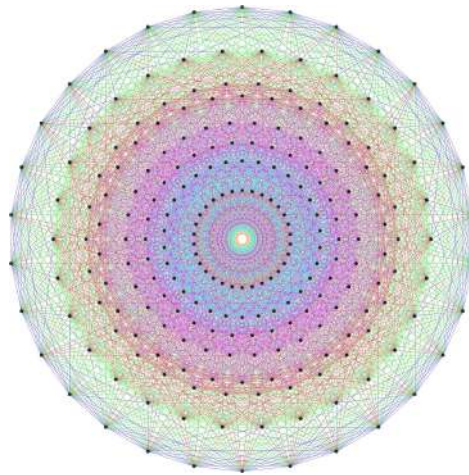

FIG. 1: E_8 Petrie projection

I. INTRODUCTION

Fig. 1 is the Petrie projection of the largest of the exceptional simple Lie algebras, groups and lattices called E_8 . It has 240 vertices and 6720 edges of 8 dimensional (8D) length $\sqrt{2}$. Interestingly, in addition to containing the 8D structures of D_8 (aka. the rectified 8-orthoplex) and BC_8 (aka. the 8 demicube or alternated octeract), E_8 has been shown to fold to the 4D Polychora of H_4 (aka. the 120 vertex 600-cell) and a scaled copy $H_4\Phi$ [10][20], where $\Phi = \frac{1}{2}(1 + \sqrt{5}) = 1.618\dots$ is the big Golden Ratio and $\varphi = \frac{1}{2}(\sqrt{5} - 1) = 1/\Phi = \Phi - 1 = 0.618\dots$ is the small Golden Ratio. Fig. 2 shows the folding orientation of E_8 and D_6 Dynkin diagrams above the H_4 and H_3 Coxeter-Dynkin diagrams (respectively).

The 600-cell is constructed from the combination of the 96 vertices of the snub 24-cell and the 24 vertices of the 24-cell shown in Fig. 3. The 24-cell is self-dual and contained within both F_4 and the triality symmetry of the D_4 Dynkin diagram. It is interesting to note that it is constructed from the 16 vertices of the BC_4 tesseract (or 8-cell or 4-cube) and the 8 vertices of its dual, the 4-orthoplex (or 16-cell). All of these polychora can be found within E_8 with the excluded 8-orthoplex. The snub 24-cell is constructed from even permutations of $\{\Phi, 1, \varphi, 0\}$. Also shown in Fig. 3 is the dual of the 600-cell, namely the 120-cell with 600 vertices and a trirectified H_4 Coxeter-Dynkin diagram (i.e. the filled node is moved to the other end).

*URL: <http://TheoryOfEverything.org/MyToE>; Electronic address: <mailto:JGMoxness@TheoryOfEverything.org>

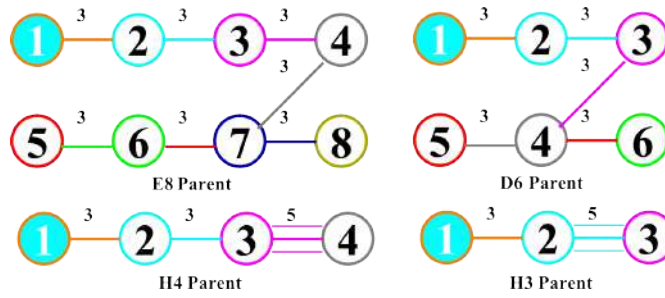

FIG. 2: E_8 and D_6 Dynkin diagrams in folding orientation with their associated Coxeter-Dynkin diagrams H_4 and H_3

4D Perspective Projections

BC4 8-Cell=4-Cube=
Tesseract;

Orthographically projects
to a 3-Cube

+ 16-Cell=4-Orthoplex=

Dual of 4-Cube; Orthographically
projects to an Octahedron; Facets
contain A3 3-Simplex

= D4 Self-Dual 24-Cell

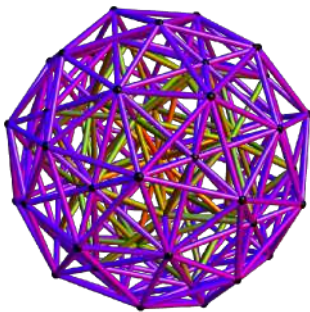
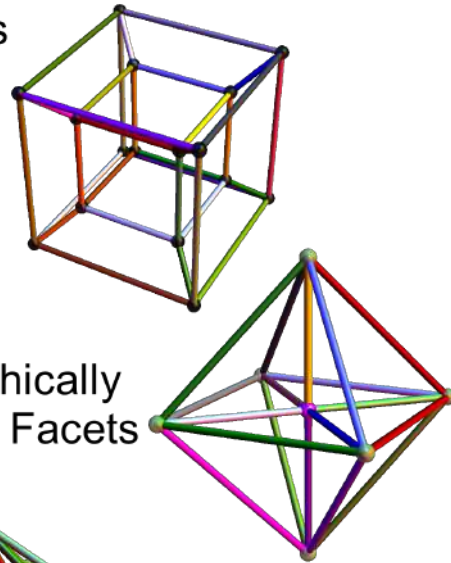

H4 600-Cell=
24-Cell+Snub 24-Cell

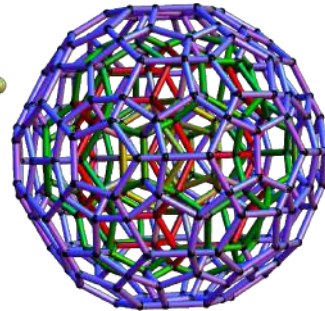
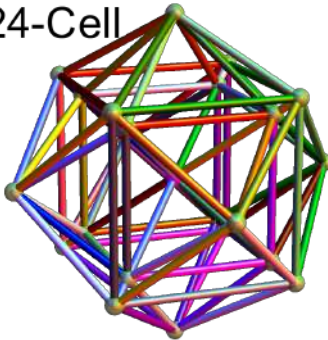

120-Cell=
Dual of 600-Cell

FIG. 3: 4D Polychora

$$H_{4\text{fold}} = \begin{pmatrix} \Phi & 0 & 0 & 0 & \varphi^2 & 0 & 0 & 0 \\ 0 & \varphi & 1 & 0 & 0 & -\varphi & 1 & 0 \\ 0 & 1 & 0 & \varphi & 0 & 1 & 0 & -\varphi \\ 0 & 0 & \varphi & 1 & 0 & 0 & -\varphi & 1 \\ \varphi^2 & 0 & 0 & 0 & \Phi & 0 & 0 & 0 \\ 0 & -\varphi & 1 & 0 & 0 & \varphi & 1 & 0 \\ 0 & 1 & 0 & -\varphi & 0 & 1 & 0 & \varphi \\ 0 & 0 & -\varphi & 1 & 0 & 0 & \varphi & 1 \end{pmatrix} \quad (1)$$

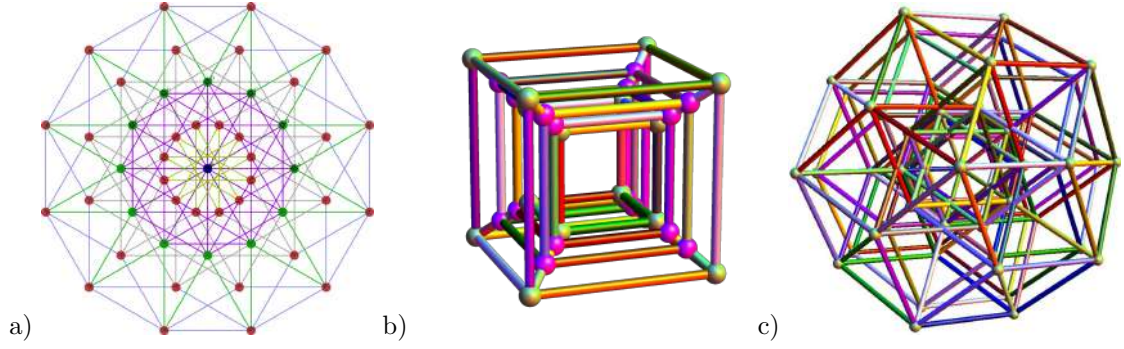

FIG. 4: The 6-cube a) Petrie projection b) 3D perspective c) rhombic triacontahedron

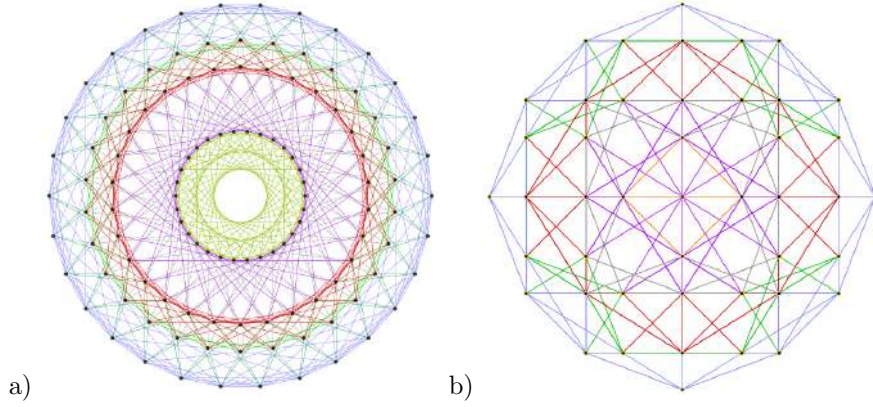

FIG. 5: H_4 600-cell 2D projections: a) Van Oss (or Petrie), b) orthonormal

The specific matrix for performing this folding of E_8 group vertices was shown[16] several years ago to be that of (1). Notice that $H_{4\text{fold}} = H_{4\text{fold}}^T$ such that it is symmetric with a quaternion-octonion Cayley-Dickson like structure. Only the first 4 rows are needed for folding E_8 to H_4 , but the 8×8 square matrix is useful in the rotation of 8D vectors by taking its inverse.

E_8 also contains the 6D structures of the 6-cube or hexeract as shown in Fig. 4. It has been shown that using rows 2 through 4 of $H_{4\text{fold}}$ projects the 6-cube[1] down to the 3D Rhombic Triacontahedron[3]. This particular object is interesting in that it contains the Platonic solids including the icosahedron and dodecahedron, and has been used to describe the Φ related geometry leading to quasicrystals[2].

II. $H_{4\text{fold}}$ MATRIX ANALYSIS

$$\begin{aligned}
 x &= \{ 0 \ 0 \ 0 \ 0 \ -\Phi 2\text{Sin} \frac{2\pi}{60} \ 0 \ 1 \ 0 \} \\
 y &= \{ 0 \ 0 \ 0 \ 0 \ 0 \ \Phi 2\text{Sin} \frac{2\pi}{30} \ 0 \ 2\text{Sin} \frac{2\pi}{15} \} \\
 z &= \{ 0 \ 0 \ 0 \ 0 \ 1 \ 0 \ \Phi 2\text{Sin} \frac{2\pi}{60} \ 0 \}
 \end{aligned} \tag{2}$$

$$\begin{aligned}
 X &= \{ 0.0522642 \quad 1/4 \quad 0 \quad -0.404508 \quad -0.221395 \quad 1/4 \quad 0 \quad 0.404508 \} \\
 Y &= \{ 0 \quad -0.27216 \quad -0.160853 \quad 0.203368 \quad 1/4 \quad 0.27216 \quad 0.497261 \quad 0.203368 \} \\
 Z &= \{ -0.154508 \quad 0.0845653 \quad 0 \quad -0.13683 \quad 0.654508 \quad 0.0845653 \quad 0 \quad 0.13683 \}
 \end{aligned} \tag{3}$$

Projection of E_8 to 2D (or 3D) requires 2 (or 3) basis vectors $\{X, Y, Z\}$. We start with those in (2), which are simply the two 2D Petrie projection basis vectors of the 600-cell (aka. the Van Oss projection) as shown in Fig. 5 a), with a 3rd z basis vector added for the 3D projection. Notice the 8D basis vectors with zero in the first 4 columns (or dimensions).

$$\text{Space-Time metric signature ST} = \{t, x, y, z\} = \{-1, 1, 1, 1\} \tag{4}$$

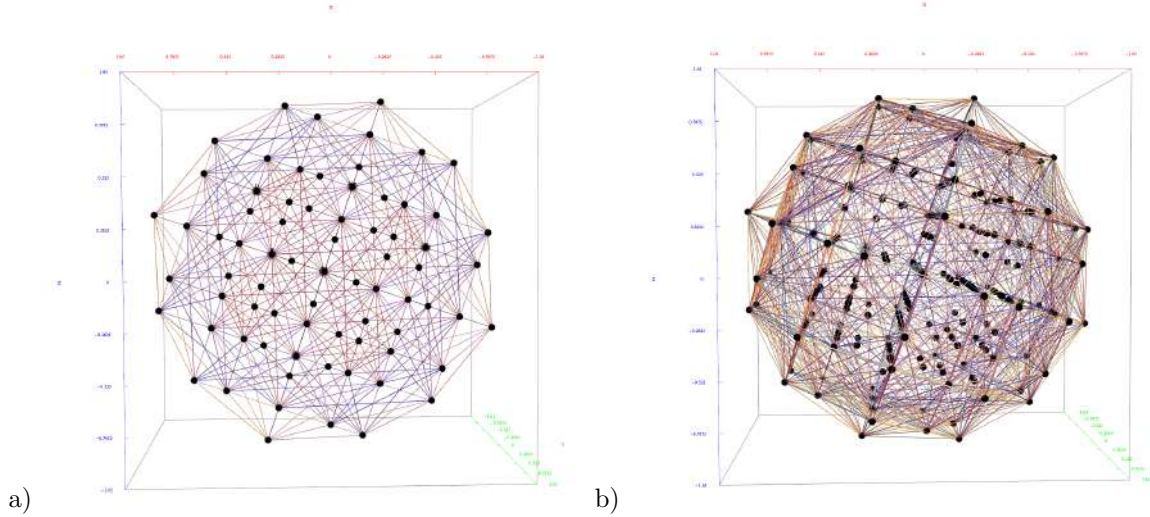

FIG. 6: E_8 projection showing H_4 and $H_4\Phi$ orthonormal face orientation in 2D and 3D perspective. Only 1220 of 6720 edges are shown in order to prevent occlusion of vertices in 3D.

$$\begin{aligned} \text{Eigenvalues: } H_{4\text{fold}} & \quad \text{eVal} = 2\{ST, \varphi ST\} \\ H_{4\text{fold}}^{-1} & \quad \text{eValInv} = \{ST, \Phi ST\}/2 \end{aligned} \quad (5)$$

$$\text{Eigenvectors of } H_{4\text{fold}} \text{ eVec} = \begin{pmatrix} 0 & -1 & 1 & 0 & 0 & -1 & 1 & 0 \\ 0 & 0 & 0 & 1 & 0 & 0 & 0 & 1 \\ 0 & 1 & 1 & 0 & 0 & 1 & 1 & 0 \\ 1 & 0 & 0 & 0 & 1 & 0 & 0 & 0 \\ 0 & 0 & 1 & -1 & 0 & 0 & -1 & 1 \\ 0 & 0 & -1 & -1 & 0 & 0 & 1 & 1 \\ 0 & -1 & 0 & 0 & 0 & 1 & 0 & 0 \\ -1 & 0 & 0 & 0 & 1 & 0 & 0 & 0 \end{pmatrix} \quad (6)$$

The E_8 projection basis (3) is obtained by $\{X, Y, Z\} = H_{4\text{fold}}^{-1} \cdot \{x, y, z\}$. On one face (or 2 of 6 cubic faces, which are the same), they project E_8 to its 2D Petrie projection shown in Fig. 1. On another face of this particular 3D projection is what would be found on all 6 faces of an orthonormal projection to 3D of the H_4 600-cell combined with a scaled $H_4\Phi$, shown in 2D on Fig. 5 b) and in 3D in Fig. 6. It is also interesting to note the $\{X, Y, Z\}$ quaternion-octonion Φ related scaling between dimensions $\{1, 5\}$ and $\{3, 7\}$, and the \pm sign pairing of $\{2, 6\}$ and $\{4, 8\}$.

In addition, the {eigenvalue, eigenvector} systemics of $H_{4\text{fold}}$ and $H_{4\text{fold}}^{-1}$ relate to the general relativistic (GR) space-time metric signature in 4 as quaternion parts of the octonion vectors in 5. The eigenvector matrix is shown in 6, where $H_{4\text{fold}} = \text{eVec}^T \cdot \text{Diag}(\text{eVal}) \cdot (\text{eVec}^T)^{-1}$. The eigenvectors of $H_{4\text{fold}}^{-1}$ are the same as those in eVec.

This pattern of eigenvalues and eigenvectors strongly suggests that E_8 (and H_4) passes through a “geometric identity” as it folds (or unfolds), respectively. This makes establishing a unit determinant of these matrices interesting. The $\text{Det}(H_{4\text{fold}}) = (4\varphi)^3(\Phi^2 - \varphi^4) = 37.3499\dots$, such that $\text{Adj}(H_{4\text{fold}}) = \text{Det}(H_{4\text{fold}}) * H_{4\text{fold}}^{-1}$. Establishing the $\text{Det}(H_{4\text{fold}}) = 1.00$ by dividing by 37.3499 is easily done. Yet, $\text{Det}(H_{4\text{fold}})/((4\varphi)^3(\Phi^2 - \varphi^4)) \approx 0$, suggesting the rows and columns of the matrices not independent.

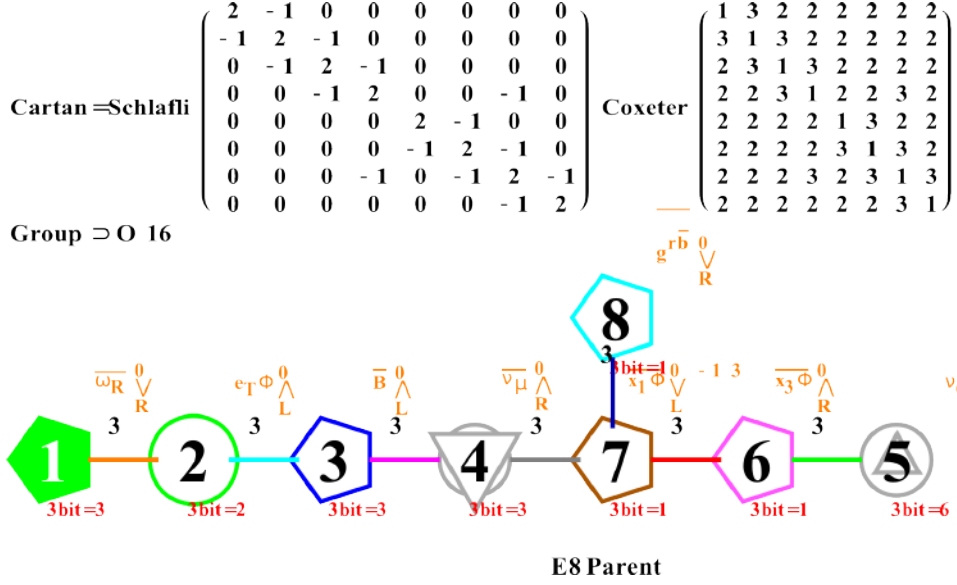

FIG. 7: E_8 Dynkin diagram with Cartan, Schlafli, and Coxeter matrices

$$E8_{\text{srm}} = \begin{pmatrix} 1 & -1 & 0 & 0 & 0 & 0 & 0 & 0 \\ 0 & 1 & -1 & 0 & 0 & 0 & 0 & 0 \\ 0 & 0 & 1 & -1 & 0 & 0 & 0 & 0 \\ 0 & 0 & 0 & 1 & -1 & 0 & 0 & 0 \\ -\frac{1}{2} & -\frac{1}{2} & -\frac{1}{2} & -\frac{1}{2} & -\frac{1}{2} & -\frac{1}{2} & -\frac{1}{2} & -\frac{1}{2} \\ 0 & 0 & 0 & 0 & 0 & 1 & 1 & 0 \\ 0 & 0 & 0 & 0 & 1 & -1 & 0 & 0 \\ 0 & 0 & 0 & 0 & 0 & 1 & -1 & 0 \end{pmatrix} \quad (7)$$

There are several choices for the form of E_8 , whether it be complex or split real (even or odd). For the purposes of this work, the form selected is split real even (SRE). While the basic topology of the E_8 Dynkin diagram is unique, it has $8!=40320$ permutations of node ordering. The node order used here is given in Fig. 7. The 240 specific E_8 group vertex values are determined from the simple roots matrix $E8_{\text{srm}}$ shown in (7). The resulting Cartan matrix and generated algebraic roots are directly dependent on these as inputs.

$$E8_{\text{Cartan}} = E8_{\text{srm}} \cdot E8_{\text{srm}}^T \quad (8)$$

$$E8_{\text{SREvertex}} = E8_{\text{srm}}^T \cdot E8_{\text{root}} \quad (9)$$

The Dynkin diagram was constructed as user input with the [Mathematica “VisibLie” notebook](#). Fig. 7 was generated and exported from the referenced tool, as are all of the figures in this paper. It has the same node ordering as the E_8 Dynkin used in Fig. 2, but is now shown with the assigned physics particles with SRE $E_8 \# \{206, 194, 184, 176, 1, 169, 170, 166\}$ that make up the simple roots matrix row entries of (7). The Cartan matrix can be generated directly by the structure of the Dynkin diagram or from its relationship to the simple roots matrix (8). The positive E_8 algebra roots are generated by the Mathematica [“SuperLie” package](#) and listed with its Hasse diagram in Appendix A. The 120 positive and 120 negative algebra roots are then used to generate the SRE E_8 vertices using (9).

E_8 GraviGUT Extended Standard Model Construction

Lisi has proposed an extended Standard Model (SM) GraviGUT based on an E_8 Lie Algebra with a fundamental physics particle associated with each of its 240 roots[11]. While the particle assignments

were modified from his original model to his current model[12], the model used here is closer to the original. It is modified slightly in order to create a complete 8-bit quantum pattern consistent with Figures 9 and 10. The complete E_8 vertex to particle and octonion assignments are listed for reference in Appendix B. The construction of this model is based on the $256 = 2^8$ binary pattern from the 9th row of the Pascal triangle $\{1, 8, 28, 56, 70, 56, 28, 8, 1\}$ and its associated Cl_8 Clifford Algebra, shown in Fig. 8.

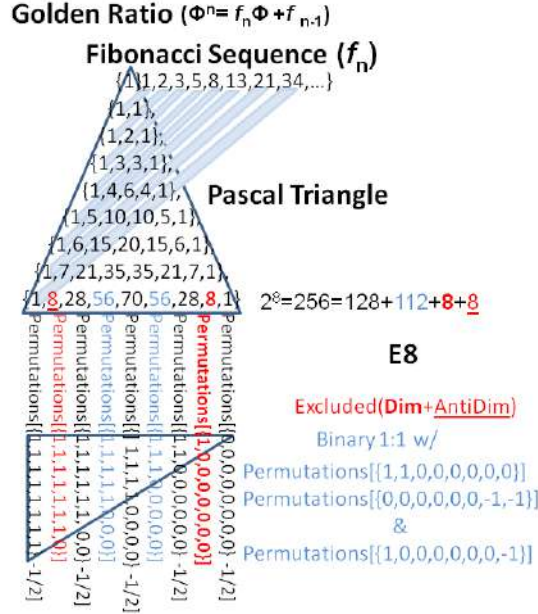

FIG. 8: SRE E_8 construction from Pascal Triangle, Cl_8 Clifford Algebra and binary permutations

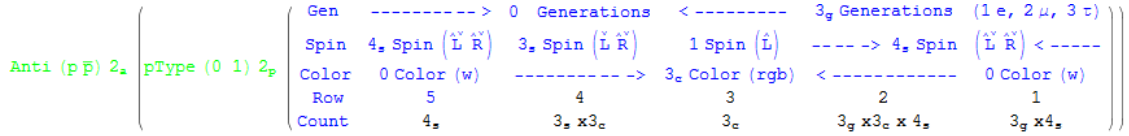

FIG. 9: Particle flavor counts given quantum number assignments

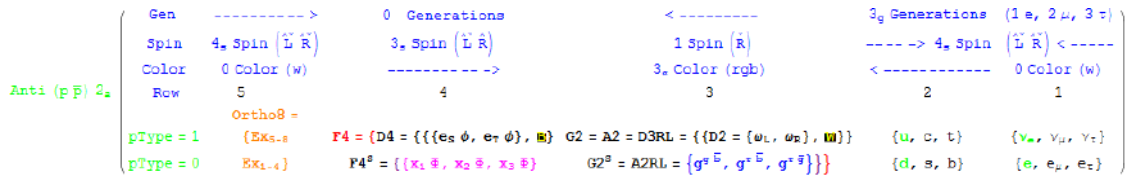

FIG. 10: Particle flavors in row / column groups with boson {group} coloring based on Lie group assignments (F_4 , F_4^B , $D_4 \& G_2$, G_2^B)

In this model, the 16 particles associated with columns 2 and 8 of the 9th row of the Pascal triangle $\{8, 8\}$ are excluded as dimensional generators from the permutations of $\{\pm 1, 0, 0, 0, 0, 0, 0, 0\}$. These excluded particles are associated with the 8-orthoplex (dual of the 8-cube with 256 vertices). While the positive generators are added to the “dimension count” of E_8 , they are not included as vertices per se, but they do show up in the projections as the axis of the basis vectors. This leaves E_8 with its 120 positive roots and 120 negative roots in the other 7 columns of the Pascal triangle.

The SRE E_8 roots are defined by combining the $112 = \{56, 56\}$ integer roots of Lie group $D_8 = SO(16)$ with $128 = \{1, 28, 70, 28, 1\}$ half integer roots of Lie group $BC_8 = Sp(16)$. Specifically, D_8 contains all permutations of $\{\pm 1, \pm 1, 0, 0, 0, 0, 0, 0\}$ and BC_8 contains all permutations of $\{\pm 1, \pm 1, \pm 1, \pm 1, \pm 1, \pm 1, \pm 1, \pm 1\}/2$ with an even number of plus signs (an 8 demicube or even 7-cube).

There are 48 assigned D_8 integer bosons and only 128 C_8 half-integer vertices available. Yet, with $192 = 64 * 3$ generation fermions in SM, the meaning or validity of assigning a generation of fermions to the remaining 64 D_8 integer vertices has been hotly debated[7]. In this model, the remaining 64 integer vertices are assigned to the 2nd generation fermions. For a complete reference of particle assignments, see Appendix B.

The specific particle assignments are determined by the configuration of the particle {spin, color, generation, flavor and type} and the patterns within E_8 . The particle type $\{e, \nu_e\}$ or $\{u, d\}$ and spin $\{\check{L}, \hat{R}, \hat{L}, \check{R}\}$ are assigned or encoded in the positions or dimensions $\{1, 2, 3, 4\}$ of each E_8 vertex. The generations are encoded in position $\{5\}$, and color in positions $\{6, 7, 8\}$. The antiparticle operation is simply the negation of the E_8 vertex (or in the binary representation “inverted” $0 \Leftrightarrow 1$ as shown in Fig. 8). It should be noted that although the positive roots of the algebra are not all assigned as “particles”, the negation of the root does represent the “anti” particle operation on the assigned particle. The charge calculation for the particles is obtained by $Q = E_{8SREvertex} \cdot \{0, 0, 0, -3, 0, 1, 1, 1\}/3$. This provides accurate results for the generation 0 bosons and 1st and 3rd generation fermions. It shows interesting deviations for some of the 2nd generation fermions that have been assigned to the D_8 integer vertices.

It is also helpful to note that the entire binary and SRE vertex list (as constructed in Fig. 8 and listed in Appendix B) is lexicographically ordered from negative to positive with a left-right and bottom-top mirroring about the middle, between the 128th and 129th of 256 vertices, which are the \hat{R} tau neutrinos ν_τ and $\bar{\nu}_\tau$. Also of interest are the first and last vertex particles which are rows $\{1, 9\}$ of the Pascal Triangle with all 0 or all 1/2 entries. These are the \hat{R} electron neutrinos ν_e and $\bar{\nu}_e$. This integrated model aligns well with the idea that it is associated with (T)ime reversal in the Charge-Parity-Time (CPT) conservation laws and points to the special consideration needed for the right handed neutrinos in the SM.

III. THE QUANTUM BIT-WISE PARTICLE ASSIGNMENTS

The 1:1 bit-wise correspondence of a particle’s quantum number assignments is a big-endian (left most significant) zero-based 8 dimensional vector $\{7-0\}$. The assignments are $\{1 \text{ antiparticle bit}=\{\mathbf{a}\}(p/\bar{p}), 1 \text{ p}_{\text{type}} \text{ bit}=\{\mathbf{p}\}(e/\nu \text{ leptons or } u/d \text{ quark}), 2 \text{ color bits}=\{c1, c0\}(w=0 \text{ or none/r/g/b}), 2 \text{ spin bits}=\{s1, s0\}(\check{L}, \hat{R}, \hat{L}, \check{R}), \text{ and } 2 \text{ generation bits}=\{g1, \mathbf{g0}\}(0=\text{bosons}/e/\mu/\tau)\}$ or simply $\{\mathbf{a}, \mathbf{p}, s1, s0, c1, c0, g1, \mathbf{g0}\}$. The **bold** type face indicates quantum assignments which are not only allocated to an SRE E_8 vertex dimension as described above, but are exhibited in the inherent structural symmetry of the E_8 algebra, group or lattice. These **bold** bits are used to define the 3 bit structure of (10) associated with the E_8 Dynkin diagram in Fig. 7.

$$E_8 \text{ Dynkin}_3 \text{ bit} = \begin{pmatrix} \mathbf{3bit} = & 0 & 1 \\ 4 = 2^2 & \mathbf{g0} & \text{Boson Fermion} \\ & & \text{Gen 0-2 Gen 1-3} \\ 2 = 2^1 & \mathbf{p} & e/d \quad \nu/u \\ 1 = 2^0 & \mathbf{a} & p \quad \bar{p} \end{pmatrix} \quad (10)$$

$$\text{Physics}_{\text{rot}} = \begin{pmatrix} 1 & 0 & 0 & 0 & 0 & 0 & 0 & 0 \\ 0 & 1 & 0 & 0 & 0 & 0 & 0 & 0 \\ 0 & 0 & \frac{1}{\sqrt{2}} & -\frac{1}{\sqrt{2}} & 0 & 0 & 0 & 0 \\ 0 & 0 & \frac{1}{\sqrt{2}} & \frac{1}{\sqrt{2}} & 0 & 0 & 0 & 0 \\ 0 & 0 & 0 & 0 & 1 & 0 & 0 & 0 \\ 0 & 0 & 0 & 0 & 0 & \frac{1}{\sqrt{3}} & \frac{1}{\sqrt{3}} & \frac{1}{\sqrt{3}} \\ 0 & 0 & 0 & 0 & 0 & -\frac{1}{\sqrt{2}} & \frac{1}{\sqrt{2}} & 0 \\ 0 & 0 & 0 & 0 & 0 & -\frac{1}{\sqrt{6}} & -\frac{1}{\sqrt{6}} & \sqrt{\frac{2}{3}} \end{pmatrix} \quad (11)$$

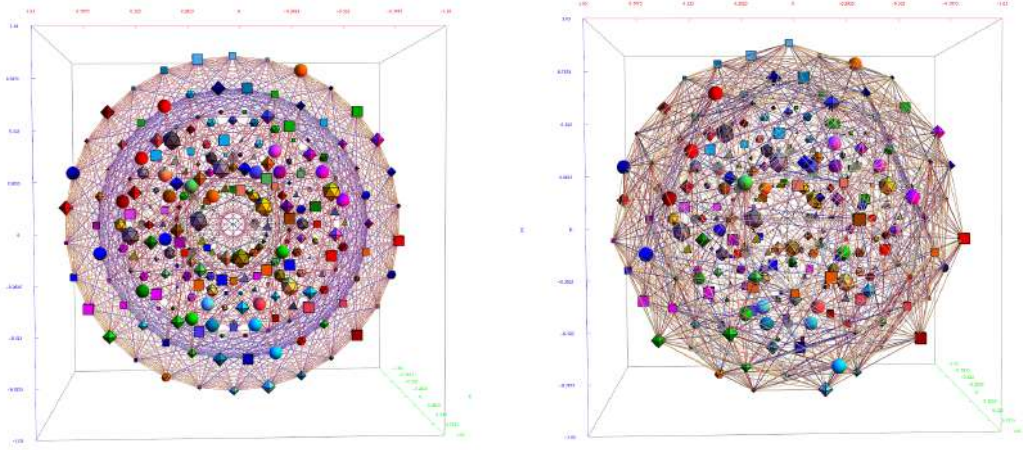

FIG. 11: E_8 showing the Petrie projection face orientation in 2D and 3D perspective with vertices as physics particle assignments. Vertex shape, size, color/shade are assigned based on extended Standard Model particle assignments. Only 1220 of 6720 edges are shown in order to prevent occlusion of vertices in 3D perspective.

$$\text{Fermionic Triality}_{\text{rot}} = \frac{1}{2} \begin{pmatrix} -1 & 1 & 1 & -1 & 0 & 0 & 0 & 0 \\ -1 & 1 & -1 & 1 & 0 & 0 & 0 & 0 \\ -1 & -1 & 1 & 1 & 0 & 0 & 0 & 0 \\ 1 & 1 & 1 & 1 & 0 & 0 & 0 & 0 \\ 0 & 0 & 0 & 0 & -1 & -1 & -1 & -1 \\ 0 & 0 & 0 & 0 & 1 & 1 & -1 & -1 \\ 0 & 0 & 0 & 0 & 1 & -1 & 1 & -1 \\ 0 & 0 & 0 & 0 & 1 & -1 & -1 & 1 \end{pmatrix} \quad (12)$$

$$\text{Bosonic Triality}_{\text{rot}} = \frac{1}{3} \begin{pmatrix} 3 & 0 & 0 & 0 & 0 & 0 & 0 & 0 \\ 0 & 0 & 0 & -3 & 0 & 0 & 0 & 0 \\ 0 & 3 & 0 & 0 & 0 & 0 & 0 & 0 \\ 0 & 0 & -3 & 0 & 0 & 0 & 0 & 0 \\ 0 & 0 & 0 & 0 & 0 & 0 & 0 & 0 \\ 0 & 0 & 0 & 0 & 0 & -2 & -1 & 2 \\ 0 & 0 & 0 & 0 & 0 & 2 & -1 & -1 \\ 0 & 0 & 0 & 0 & 0 & -1 & 2 & -1 \end{pmatrix} \quad (13)$$

As already described for the E_8 vertices, the $\{\mathbf{a}\}$ bit splits the 128 particles from 128 anti-particles. The $\{\mathbf{g0}\}$ bit splits the generation 0 boson family of 128(=112 integer roots of D_8+16 excluded integer roots of the 8-orthoplex) from the 128 half integer root (and half integer spin) of C_8 fermions. The $\{\mathbf{p}\}$ bit splits all particle families into two types, referenced in the leptons as electron and neutrino types, while the quarks are designated by up and down types. It splits the integer bosons into 2 types as well, which is a key feature of this model over the original Lisi model.

These differences are most easily seen in the 8×8 rotation matrix used for transforming SRE coordinates to physics coordinates (11) and those matrices used in identifying fermionic (12) and bosonic (13) triality transformations. Just as the E_8 to H_4 folding matrix has symmetric quaternion quadrants in the octonion matrix, the physics and triality rotation matrices are divided by an upper left quadrant affecting the SRE $\{1-4\}$ spin positions and a lower right quadrant affecting the SRE $\{5-8\}$ generation-color positions. As a matter of fact, the physics rotation clearly operates on the SRE E_8 vertices by pairing them into 4 sets, specifically $p_{\text{type}} \{1,2\}$, spin $\{3,4\}$, generation $\{5,6\}$ and color $\{7,8\}$. This physics rotation is more dramatically shown in the next section on triality.

Visualizing this E_8 based physics model by projection to 2D and 3D with vertex shape, size and color assigned based on the described patterns is now possible. Using the direct relationship to lower dimensional geometry symmetries provided by the folding matrix provides the flexibility to select the

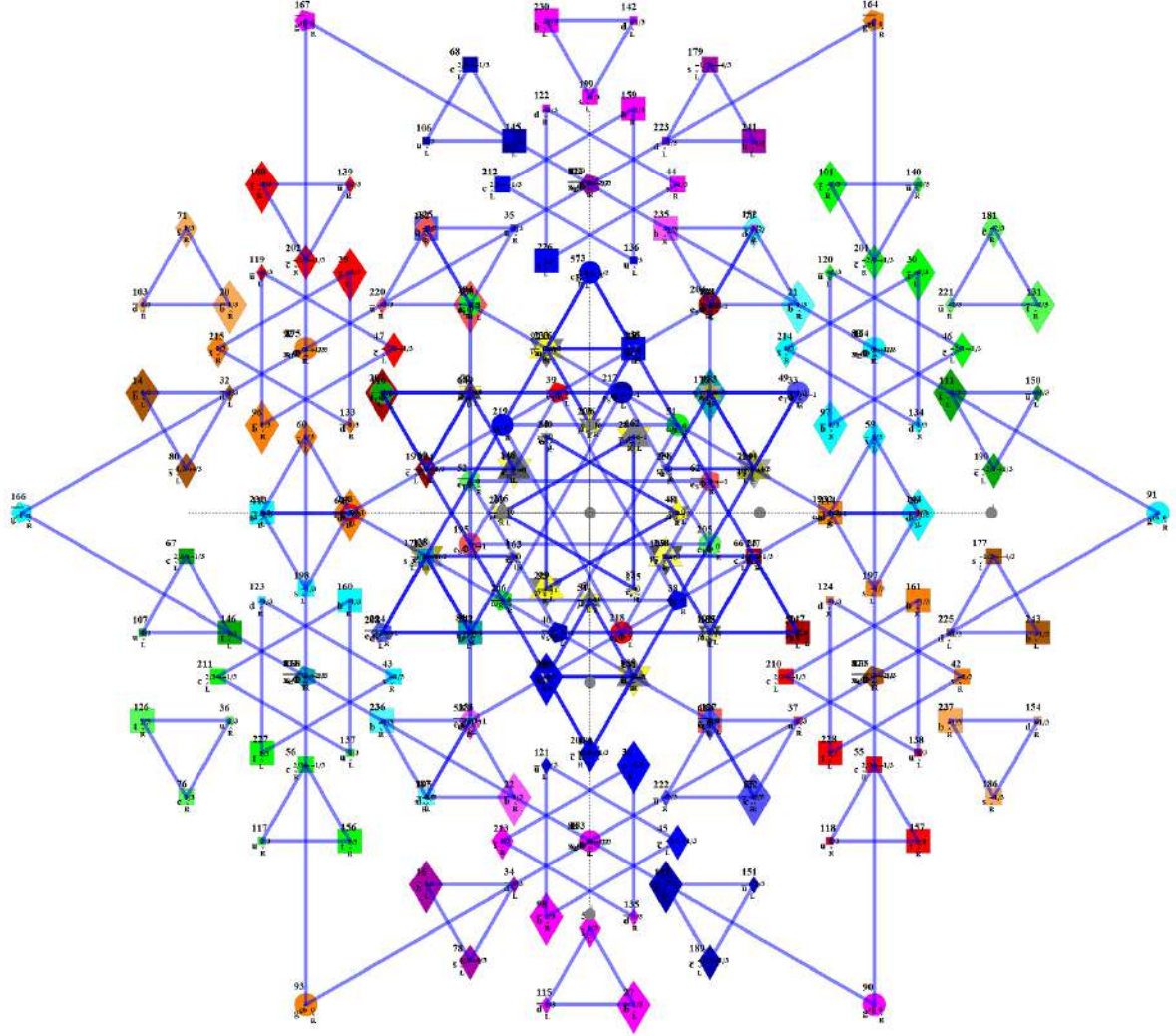

FIG. 12: E_8 with vertices rotated to physics coordinates and projected from 8D \rightarrow 2D, with 86=22 bosonic+64 fermionic triality generated *equilateral* triangles. Vertex shape, size, color/shade are assigned based on extended Standard Model particle assignments

contents of the visualization based on the quantum physics parameters of the model and not just the math of the geometry. A few examples are shown in Fig. 11.

Triality Relationships

The Lisi model also demonstrates a consistency with the bosons and fermions that is related to the triality relationships within E_8 . This is shown in Fig. 12 with blue triality lines linking the 3 generations of each fermion using (12). Applying the triality rotation matrix as a dot product against an SRE vector gives the 2nd generation fermion particle. Applying it again gives the 3rd generation. Applying it a 3rd time returns to the 1st generation fermion. The bosons are also involved in triality relationships as well using (13), rotating through red, green, and blue particle color assignments.

It is interesting to note that the quarks $\{r/g/b, p/\bar{p}\}$ are all located on 6 corresponding dual concentric circles around the center. The leptons are hexagonal “Star of David” patterns in the center, while the bosons are in single or dual hexagonal rings radiating from the center.

$$\text{Triality}_{\text{basis}} \begin{aligned} H &= \left\{ 2 - \frac{4}{\sqrt{3}} \quad 0 \quad 0 \quad \sqrt{2} - \sqrt{\frac{2}{3}} \quad 0 \quad 0 \quad , \sqrt{2} \quad 0 \quad \right\} \\ V &= \left\{ \quad 0 \quad \frac{4}{\sqrt{3}} - 2 \quad \sqrt{\frac{2}{3}} - \sqrt{2} \quad 0 \quad 0 \quad 0 \quad 0 \quad -\sqrt{2} \quad \right\} \end{aligned} \quad (14)$$

The axis shown in Fig. 12 are rotated to physics coordinates using (11), which puts the basis vectors (14) on the projected (H)orizontal and (V)ertical axis. It seems to clarify dimensional identities as well. For example, when the {1, 2, 3} dimensions are moved (i.e. using axis locators in the tool), all vertices change positions except the $p_{\text{type}=0}$ bosons {g gluons, $x_n\Phi$ }. Moving dimension {4} preserves these as well as the \hat{L} and \check{R} quark positions. Moving the dimensions {5, 6} preserves these, except now the row 4 $p_{\text{type}=0}$ bosons { $x_n\Phi$ } emerge from the 6 triple overlap points at center of the quark's concentric rings (the intersection of the gluons triality lines). And finally, the {7, 8} dimensions in physics can be identified with quark color, as {7} preserves the blue quark positions, while {8} moves the dual concentric rings of quarks while preserving their relative positions within the rings. It is interesting to note that the dimensions {6, 7, 8} are appropriately labeled {r, g, b} in SRE coordinates, since in this projection the SRE math coordinates are located at the aforementioned 6 triple overlap points at center of the quark's $\{\bar{r}, g, \bar{g}, b, \bar{b}\}$ concentric rings (the intersection of the gluons triality lines).

IV. E_8 TO H_4 FOLDING'S APPLICATION TO THEORETICAL PHYSICS

$H_{4\text{fold}}$ provides a new and more direct relationship between E_8 and its lower dimensional geometric objects such as H_4 . This has allowed for improvements to E_8 related physics models, such as those of Lisi[11]. This theoretical model is shown to provide $E_{8\text{SRE}}$ assigned particles as fundamental building blocks for generating the rest of the 240 E_8 vertex mapped particles[14].

Those specific particle assignments now also include their association to 8 bitwise quantum numbers, which are; the anti-particle bit, the particle type bit $\{e, \nu_e\}$ or $\{u, d\}$, 2 spin bits $\{\check{L}, \hat{R}, \hat{L}, \check{R}\}$, 2 color bits $\{w = 0, r, g, b\}$, and 2 generation bits $\{0, 1, 2, 3\}$. This capability of mapping specific particles to E_8 has allowed the verification of related results[9].

This has also allowed for improved charge calculations in Lisi's extended GraviGUT integrated Standard Model (SM)[12]. This was done through the analysis of variations associated with a particular association of generation 0 bosons and generation 1-3 fermions with H_4 and $H_4\Phi$ [19].

E_8 has also been shown to be related to an 8 dimensional Charge-Parity-Time (CPT) construct for a Theory of Everything (ToE)[13]. This now includes particle mass predictions such as a Higgs mass of 124.443...GeV[15], which is within the current error bars of the LHC CMS experiment results for a discovered Higgs particle mass of 124.70 ± 0.31 (stat) ± 0.15 (syst) GeV[6]. More particle mass predictions based on the model have been found to be within standard experimental error. Other mass predictions are suggested by the features of this integrated geometry based physics model and are an active part of the author's research on the topic.

V. OCTONIONS AND E_8 WITH H_4 FOLDING

In addition to mapping extended SM particle quantum bits between H_4 and the SRE E_8 vertices and algebra roots, they [have been mapped](#)[17] to the 480 unique permutations of octonions[5] and [the 3840 split octonions](#)[18] through a common pattern associated with the quantum bits. This octonionic mapping provides valuable insight into related theoretical physics models.

$$\begin{aligned} &\text{Fano plane triads} \\ &\{\{1, 2, 4\}, \{1, 3, 7\}, \{1, 5, 6\}, \{2, 3, 5\}, \{2, 6, 7\}, \{3, 4, 6\}, \{4, 5, 7\}\} \\ &\text{Flattened triads} \\ &\{1, 4, 2, 3, 7, 5, 6\} \\ &\text{Mask bits} \\ &\{0, 0, 0, 0, 0, 0, 0\} \end{aligned} \quad (15)$$

The double cover of the 240 vertices requires the addition of a 9th "flip" bit that operates on the

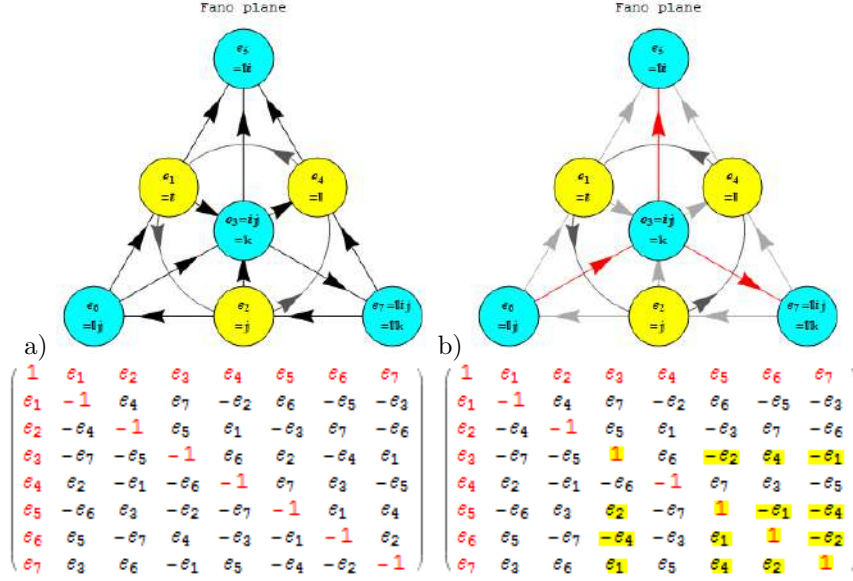

FIG. 13: Octonion representations: a) Fano plane, b) 1st triad split Fano plane

Fano plane representation by reversing two of the midpoint nodes in the Fano plane triads (i.e. those with circular directed edges in Fig. 13). These node numbers are always indicated by the 2nd and 3rd columns of the flattened triads as shown in (15). They are bolded when reversed (or “flipped”), which shows this particular octonion has the flip bit set. The flattened triad is simply created by taking in sequence the numbers from the first triad along with the last two numbers in the 2nd and 3rd triads. It operates to define the node numbers for each canonical position of the Fano plane mnemonic.

As it was for the permutation of node numbers in Dynkin diagrams, there are many permutations of node number and arrow direction in the octonion Fano plane which are equivalent. What is important is the representation of the triads given in (15). This particular set of triads is equivalent to that used in Baez’ work on octonions[4].

$$\begin{aligned}
& \begin{array}{l}
1 \ \{\{1, 2, 3\}, \{1, 4, 5\}, \{1, 6, 7\}, \{2, 4, 6\}, \{2, 5, 7\}, \{3, 4, 7\}, \{3, 5, 6\}\} \\
2 \ \{\{1, 2, 3\}, \{1, 4, 5\}, \{1, 6, 7\}, \{2, 4, 7\}, \{2, 5, 6\}, \{3, 4, 6\}, \{3, 5, 7\}\} \\
3 \ \{\{1, 2, 3\}, \{1, 4, 6\}, \{1, 5, 7\}, \{2, 4, 5\}, \{2, 6, 7\}, \{3, 4, 7\}, \{3, 5, 6\}\} \\
4 \ \{\{1, 2, 3\}, \{1, 4, 6\}, \{1, 5, 7\}, \{2, 4, 7\}, \{2, 5, 6\}, \{3, 4, 5\}, \{3, 6, 7\}\} \\
5 \ \{\{1, 2, 3\}, \{1, 4, 7\}, \{1, 5, 6\}, \{2, 4, 5\}, \{2, 6, 7\}, \{3, 4, 6\}, \{3, 5, 7\}\} \\
6 \ \{\{1, 2, 3\}, \{1, 4, 7\}, \{1, 5, 6\}, \{2, 4, 6\}, \{2, 5, 7\}, \{3, 4, 5\}, \{3, 6, 7\}\} \\
7 \ \{\{1, 2, 4\}, \{1, 3, 5\}, \{1, 6, 7\}, \{2, 3, 6\}, \{2, 5, 7\}, \{3, 4, 7\}, \{4, 5, 6\}\} \\
8 \ \{\{1, 2, 4\}, \{1, 3, 5\}, \{1, 6, 7\}, \{2, 3, 7\}, \{2, 5, 6\}, \{3, 4, 6\}, \{4, 5, 7\}\} \\
9 \ \{\{1, 2, 4\}, \{1, 3, 6\}, \{1, 5, 7\}, \{2, 3, 5\}, \{2, 6, 7\}, \{3, 4, 7\}, \{4, 5, 6\}\} \\
10 \ \{\{1, 2, 4\}, \{1, 3, 6\}, \{1, 5, 7\}, \{2, 3, 7\}, \{2, 5, 6\}, \{3, 4, 5\}, \{4, 6, 7\}\} \\
11 \ \{\{1, 2, 4\}, \{1, 3, 7\}, \{1, 5, 6\}, \{2, 3, 5\}, \{2, 6, 7\}, \{3, 4, 6\}, \{4, 5, 7\}\} \\
12 \ \{\{1, 2, 4\}, \{1, 3, 7\}, \{1, 5, 6\}, \{2, 3, 6\}, \{2, 5, 7\}, \{3, 4, 5\}, \{4, 6, 7\}\} \\
13 \ \{\{1, 2, 5\}, \{1, 3, 4\}, \{1, 6, 7\}, \{2, 3, 6\}, \{2, 4, 7\}, \{3, 5, 7\}, \{4, 5, 6\}\} \\
14 \ \{\{1, 2, 5\}, \{1, 3, 4\}, \{1, 6, 7\}, \{2, 3, 7\}, \{2, 4, 6\}, \{3, 5, 6\}, \{4, 5, 7\}\} \\
15 \ \{\{1, 2, 5\}, \{1, 3, 6\}, \{1, 4, 7\}, \{2, 3, 4\}, \{2, 6, 7\}, \{3, 5, 7\}, \{4, 5, 6\}\} \\
16 \ \{\{1, 2, 5\}, \{1, 3, 6\}, \{1, 4, 7\}, \{2, 3, 7\}, \{2, 4, 6\}, \{3, 4, 5\}, \{5, 6, 7\}\} \\
17 \ \{\{1, 2, 5\}, \{1, 3, 7\}, \{1, 4, 6\}, \{2, 3, 4\}, \{2, 6, 7\}, \{3, 5, 6\}, \{4, 5, 7\}\} \\
18 \ \{\{1, 2, 5\}, \{1, 3, 7\}, \{1, 4, 6\}, \{2, 3, 6\}, \{2, 4, 7\}, \{3, 4, 5\}, \{5, 6, 7\}\} \\
19 \ \{\{1, 2, 6\}, \{1, 3, 4\}, \{1, 5, 7\}, \{2, 3, 5\}, \{2, 4, 7\}, \{3, 6, 7\}, \{4, 5, 6\}\} \\
20 \ \{\{1, 2, 6\}, \{1, 3, 4\}, \{1, 5, 7\}, \{2, 3, 7\}, \{2, 4, 5\}, \{3, 5, 6\}, \{4, 6, 7\}\} \\
21 \ \{\{1, 2, 6\}, \{1, 3, 5\}, \{1, 4, 7\}, \{2, 3, 4\}, \{2, 5, 7\}, \{3, 6, 7\}, \{4, 5, 6\}\} \\
22 \ \{\{1, 2, 6\}, \{1, 3, 5\}, \{1, 4, 7\}, \{2, 3, 7\}, \{2, 4, 5\}, \{3, 4, 6\}, \{5, 6, 7\}\} \\
23 \ \{\{1, 2, 6\}, \{1, 3, 7\}, \{1, 4, 5\}, \{2, 3, 4\}, \{2, 5, 7\}, \{3, 5, 6\}, \{4, 6, 7\}\} \\
24 \ \{\{1, 2, 6\}, \{1, 3, 7\}, \{1, 4, 5\}, \{2, 3, 5\}, \{2, 4, 7\}, \{3, 4, 6\}, \{5, 6, 7\}\} \\
25 \ \{\{1, 2, 7\}, \{1, 3, 4\}, \{1, 5, 6\}, \{2, 3, 5\}, \{2, 4, 6\}, \{3, 6, 7\}, \{4, 5, 7\}\} \\
26 \ \{\{1, 2, 7\}, \{1, 3, 4\}, \{1, 5, 6\}, \{2, 3, 6\}, \{2, 4, 5\}, \{3, 5, 7\}, \{4, 6, 7\}\} \\
27 \ \{\{1, 2, 7\}, \{1, 3, 5\}, \{1, 4, 6\}, \{2, 3, 4\}, \{2, 5, 6\}, \{3, 6, 7\}, \{4, 5, 7\}\} \\
28 \ \{\{1, 2, 7\}, \{1, 3, 5\}, \{1, 4, 6\}, \{2, 3, 6\}, \{2, 4, 5\}, \{3, 4, 7\}, \{5, 6, 7\}\} \\
29 \ \{\{1, 2, 7\}, \{1, 3, 6\}, \{1, 4, 5\}, \{2, 3, 4\}, \{2, 5, 6\}, \{3, 5, 7\}, \{4, 6, 7\}\} \\
30 \ \{\{1, 2, 7\}, \{1, 3, 6\}, \{1, 4, 5\}, \{2, 3, 5\}, \{2, 4, 6\}, \{3, 4, 7\}, \{5, 6, 7\}\}
\end{array}
\end{aligned} \tag{16}$$

$$\begin{aligned}
& \begin{array}{l}
1 \ \{00, 07, 19, 1E, 2A, 2D, 33, 34\} \\
2 \ \{01, 06, 18, 1F, 2B, 2C, 32, 35\} \\
3 \ \{02, 05, 1B, 1C, 28, 2F, 31, 36\} \\
4 \ \{03, 04, 1A, 1D, 29, 2E, 30, 37\} \\
5 \ \{08, 0F, 11, 16, 22, 25, 3B, 3C\} \\
6 \ \{09, 0E, 10, 17, 23, 24, 3A, 3D\} \\
7 \ \{0A, 0D, 13, 14, 20, 27, 39, 3E\} \\
8 \ \{0B, 0C, 12, 15, 21, 26, 38, 3F\}
\end{array}
\end{aligned} \tag{17}$$

$$\text{sm2fpi} = \{5, 8, 4, 3, 7, 6, 3, 2, 6, 5, 1, 4, 6, 7, 3, 3, 8, 6, 3, 1, 6, 6, 2, 3, 5, 8, 4, 4, 3, 7, 6\} \tag{18}$$

There are 30 canonical sets of 7 triads indexed with a Fano plane index (fpi) in (16). As in E_8 with 16 of the $2^8 = 256$ binary representations excluded from the group, there are 32 excluded octonions from the $2^9 = 512$. As in E_8 , excluded particles are associated with the color=0, generation=0 (bosons) which are the positive (and negative) generators commonly associated with the 8-orthoplex with 16 permutations of $\{\pm 1, 0, 0, 0, 0, 0, 0\}$.

In order to make a valid octonion, each fpi gets one of 8 possible 7-bit sign masks (sm) applied (17). Since each sm can be “inverted” ($0 \Leftrightarrow 1$ as we do with the anti-particle quantum bit), this gives $16 * 30 = 480$ octonion permutations.

The sign mask operates on the triads by reversing the 2nd and 3rd numbers from canonical (numerical) order when the mask bit is set on that triad’s position. Each sign mask operation acting on the 30 fpi’s can be permuted in consistent ways to produce the many isomorphic sets of 480 octonions. Since they are bit-wise operations, the sign masks use hexadecimal notation with the first bit always 0. It is interesting to note that there are only 2 octonions that use a sign mask of 00H. The one shown and another discovered by Dixon[8].

The 8 sets of 8 sm are assigned to the 30 fpi given in (18), so if fpi=1, the 5th sm group is selected. Since the octonion in Fig. 13 has fpi=11 and the 11th sm2fpi=1, this means sm bits will index to the 1st sm group in (17).

$$\begin{array}{l} \text{Assigned Particle and} \\ \text{SRE } E_8\#177 = \underset{\text{r}}{\overset{\text{L}}{s^{-1/3}}} \end{array} \quad \begin{array}{l} \text{Quantum bits } \{apccs\} \\ \{00010010\} \end{array} \quad (19)$$

In this integrated system of E_8 , particles, and octonions, the 4 bits that make up the 16 possible sign masks are associated with the 4 quantum particle bits {anti, p_{type} , and 2 spin bits}. Looking deeper at the space-(P)arity orientation pattern, where pitch and roll rotations are associated with the up/down and left/right spin bits, a conjecture is made that the p_{type} bit can be thought of as a 3rd spin bit, giving a 3rd spin type which we might call “in/out” or yaw rotation. Since according to (19) the octonion in Fig. 13 has $p_{\text{type}}=0$, and spin=00 or \checkmark , this means sm=1, so it gets the 1st sign mask of the 1st sm group, giving sm=00H.

The assignment of the 30 fpi's is based on the 4 color and generation bits that are not both 0 (or excluded) giving $2^4 - 1 = 15$. It is not simply a naive index created by simply adding the flip bit to the index. The extra logic needed to index $2*15$ is based on a pattern discovered that relates how the anti and flip bits operate across the generation and color bits. Specifically, this pattern differentiates the 128 1/2 integer E_8 vertices associated with the BC_8 group (2 generations of fermions) from the integer 112 vertices in the D_8 group (bosons plus an anomalous generation=2 set of fermions).

VI. CONCLUSION

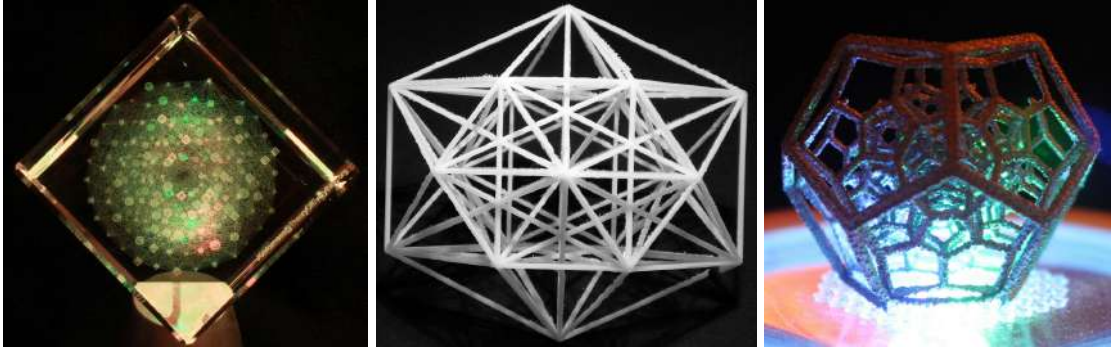

FIG. 14: The E_8 to H_4 3D projection model used to laser etch optical crystal

In terms of mathematical symmetry representing the beauty of Nature, E_8 is one of the most beautiful. It contains a wealth of symmetries, including those of 2D projections, 3D polyhedrons, 4D polychora, and those up to 8D. An SRE E_8 to H_4 folding matrix was determined and used to fold E_8 to the 120 4D vertices of the H_4 600-cell and 120 vertices of $H_4\Phi$. A direct relationship between the simple roots matrix and theoretical physics models was introduced. In addition to the mapping for particles, a direct relationship to the 480 unique octonion permutations was also shown.

The traditional 2D Petrie projections of high dimensional geometry were extended by adding a carefully chosen third basis vector and generating 3D objects in either orthogonal or perspective views. The folding matrix was shown to generate these basis vectors used in projecting the E_8 vertices. These projected 3D objects can be realized as 3D models, which allow for their realization as [animated rotations](#), models laser etched in optical crystal, and in some cases 3D printed in plastic or even metal as in Fig. 14.

In addition, these new mathematical relationships and visual representations have been used to verify and improve grand unified theories which rely on these structures.

Acknowledgments

I would like to thank my wife for her love and patience and those in academia who have taken the time to review this work.

Bibliography

- [1] 6-cube. en.wikipedia.org/wiki/6-cube, December 2011.
- [2] Quasicrystal. en.wikipedia.org/wiki/Quasicrystal, December 2011.
- [3] Rhombic Triacontahedron. en.wikipedia.org/wiki/RhombicTriacontahedron, December 2011.
- [4] J. C. Baez. The Octonions. *ArXiv e-prints math/010515*, May 2001.
- [5] D. Chesley. Twisted octonions. *Personal Website*, 1988.
- [6] CMS Collaboration. Observation of the diphoton decay of the Higgs boson and measurement of its properties. *ArXiv e-prints hep-ex/1407.0558*, July 2014.
- [7] J. Distler and S. Garibaldi. There is No “Theory of Everything” Inside E_8 . *Communications in Mathematical Physics*, 298:419–436, September 2010.
- [8] G. Dixon. Octonion X-product orbits. *ArXiv e-prints hep-th/9410202*, October 1994.
- [9] A. Douglas and J. Repka. The GraviGUT Algebra Is not a Subalgebra of E_8 , but E_8 Does Contain an Extended GraviGUT Algebra. *SIGMA math.RT/1305.6946*, 10:72, July 2014.
- [10] M. Koca and N. Koca. Quaternionic Roots of E_8 Related Coxeter Graphs and Quasicrystals. *Turkish Journal of Physics*, 22:421–436, May 1998.
- [11] A. G. Lisi. An Exceptionally Simple Theory of Everything. *ArXiv e-prints hep-th/0711.0770*, November 2007.
- [12] A. G. Lisi. An Explicit Embedding of Gravity and the Standard Model in E_8 . *ArXiv e-prints gr-qc/1006.4908*, June 2010.
- [13] J. G. Moxness. A More Natural Reference Model Integrating Relativity and Quantum Mechanics. www.vixra.org/abs/1006.0063, April 1998.
- [14] J. G. Moxness. Particle Count Reduction in an E_8 Standard Model. www.vixra.org/abs/1109.0005, September 2011.
- [15] J. G. Moxness. Simplified ToE Summary (w/124.443 GeV Higgs Mass Prediction). theoryofeverything.org/TOE/JGM/ToEsummary.pdf, November 2012.
- [16] J. G. Moxness. E_8 folding to H_4+H_4/φ . www.theoryofeverything.org/pageid=1454, November 2013.
- [17] J. G. Moxness. The 480 octonions, their Fano planes and multiplication tables. theoryofeverything.org/TOE/JGM/Fano.pdf, March 2013.
- [18] J. G. Moxness. The Comprehensive Split Octonions and their Fano Planes. theoryofeverything.org/TOE/JGM/splitFano.pdf, June 2013.
- [19] J. G. Moxness. In Work. www.theoryofeverything.org/pageid=2189, November 2014.
- [20] David A. Richter. Triacontagonal coordinates for the $E(8)$ root system. *ArXiv e-prints math.GM/0704.3091*, April 2007.

62	-1	1	0	-1	0	1	0	0	0	1	1	1	1	2	2	1	9
63	1	0	0	-1	0	1	0	0	0	1	1	1	1	1	2	2	10
64	1	-1	1	0	-1	0	0	0	0	1	1	2	2	0	1	2	10
65	1	0	-1	1	1	-1	0	0	0	1	1	1	2	1	1	2	10
66	-1	0	1	0	1	-1	0	0	0	1	0	1	2	2	1	1	10
67	0	-1	0	0	0	0	1	-1	0	0	1	2	1	2	3	1	10
68	-1	1	-1	1	0	1	-1	0	0	1	1	2	1	2	2	1	10
69	1	-1	1	0	1	-1	0	0	0	1	1	2	2	1	1	2	11
70	1	0	-1	1	0	1	-1	0	0	1	1	1	2	1	2	2	11
71	-1	0	1	0	0	1	-1	0	0	1	0	1	2	2	1	2	11
72	0	1	0	0	-1	0	0	0	0	1	2	2	2	0	1	2	11
73	0	-1	0	0	0	0	0	1	0	1	0	1	2	1	2	3	11
74	-1	1	-1	0	0	0	1	-1	0	1	0	1	2	1	2	3	11
75	1	-1	1	0	0	1	-1	0	0	1	1	2	2	1	2	2	12
76	1	0	-1	0	0	0	1	-1	0	1	1	1	2	1	2	3	12
77	0	1	0	0	1	-1	0	0	0	1	2	2	2	1	1	2	12
78	-1	0	1	-1	0	0	1	-1	0	1	0	1	2	2	1	2	12
79	-1	1	-1	0	0	0	0	1	0	1	0	1	1	2	1	2	12
80	-1	0	0	1	0	0	0	-1	0	1	0	1	2	3	1	2	13
81	0	1	0	0	0	1	-1	0	0	1	1	2	2	2	1	2	13
82	-1	0	1	-1	0	0	0	1	0	1	0	1	2	2	1	2	13
83	1	-1	1	-1	0	0	1	-1	0	1	1	1	2	2	1	2	13
84	1	0	-1	0	0	0	0	1	0	1	1	1	1	2	1	2	13
85	-1	0	0	1	0	0	-1	1	0	1	0	1	2	3	1	2	14
86	1	-1	0	1	0	0	0	-1	0	1	1	1	2	3	1	2	14
87	0	1	0	-1	0	0	1	-1	0	1	1	2	2	2	1	2	14
88	1	-1	1	-1	0	0	0	1	0	1	1	1	2	2	1	2	14
89	0	1	-1	1	0	0	0	-1	0	1	1	2	2	3	1	2	15
90	1	-1	0	1	0	0	-1	1	0	1	1	1	2	3	1	2	15
91	0	1	0	-1	0	0	0	1	0	1	1	2	2	2	1	2	15
92	-1	0	0	0	0	-1	1	0	0	1	0	1	2	3	1	2	15
93	0	0	1	0	0	0	0	-1	0	1	1	2	3	3	1	2	16
94	1	-1	0	0	0	-1	1	0	0	1	1	1	2	3	1	2	16
95	0	1	-1	1	0	0	-1	1	0	1	1	2	2	3	1	2	16
96	-1	0	0	0	-1	1	0	0	0	1	0	1	2	3	1	3	16
97	0	0	1	0	0	0	-1	1	0	1	1	2	3	3	1	2	17
98	0	1	-1	0	0	-1	1	0	0	1	1	2	2	3	1	2	17
99	1	-1	0	0	-1	1	0	0	0	1	1	1	2	3	1	3	17
100	-1	0	0	0	1	0	0	0	0	1	0	1	2	3	2	3	17
101	0	1	-1	0	-1	1	0	0	0	1	1	2	2	3	1	3	18
102	0	0	1	-1	0	-1	1	0	0	1	1	2	3	3	1	2	18
103	1	-1	0	0	1	0	0	0	0	1	1	1	2	3	2	3	18
104	0	0	0	1	0	-1	0	0	0	1	1	2	3	4	1	2	19
105	0	0	1	-1	-1	1	0	0	0	1	1	2	3	3	1	3	19
106	0	1	-1	0	1	0	0	0	0	1	1	2	2	3	2	3	19
107	0	0	1	-1	1	0	0	0	0	1	1	2	3	3	2	3	20
108	0	0	0	1	-1	1	-1	0	0	1	1	2	3	4	1	3	20
109	0	0	0	0	-1	0	1	-1	0	1	1	2	3	4	1	3	21
110	0	0	0	1	1	0	-1	0	0	1	1	2	3	4	2	3	21
111	0	0	0	0	1	-1	1	-1	0	1	1	2	3	4	2	3	22
112	0	0	0	0	-1	0	0	1	0	1	1	2	3	4	1	3	22
113	0	0	0	0	1	-1	0	1	0	1	1	2	3	4	2	3	23
114	0	0	0	0	0	1	0	-1	0	1	1	2	3	4	2	4	23
115	0	0	0	0	0	1	-1	1	0	1	1	2	3	4	2	4	24
116	0	0	0	-1	0	0	1	0	0	1	1	2	3	4	2	4	25
117	0	0	-1	1	0	0	0	0	0	1	1	2	3	5	2	4	26
118	0	-1	1	0	0	0	0	0	0	1	1	2	4	5	2	4	27
119	-1	1	0	0	0	0	0	0	0	1	1	3	4	5	2	4	28
120	1	0	0	0	0	0	0	0	0	1	2	3	4	5	2	4	29

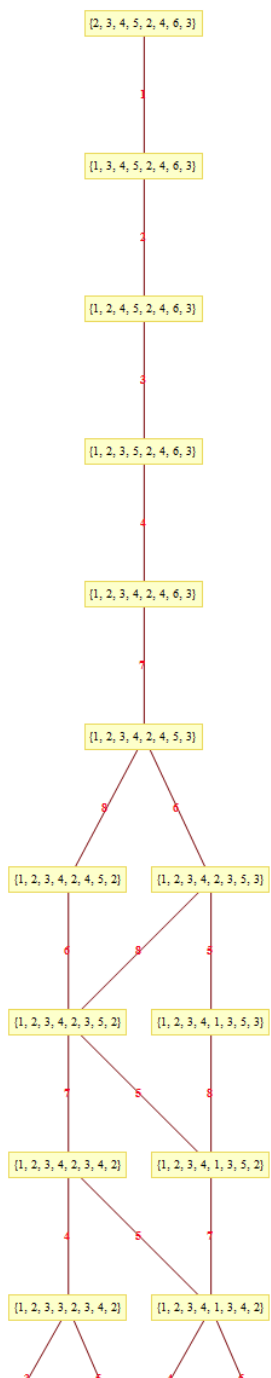

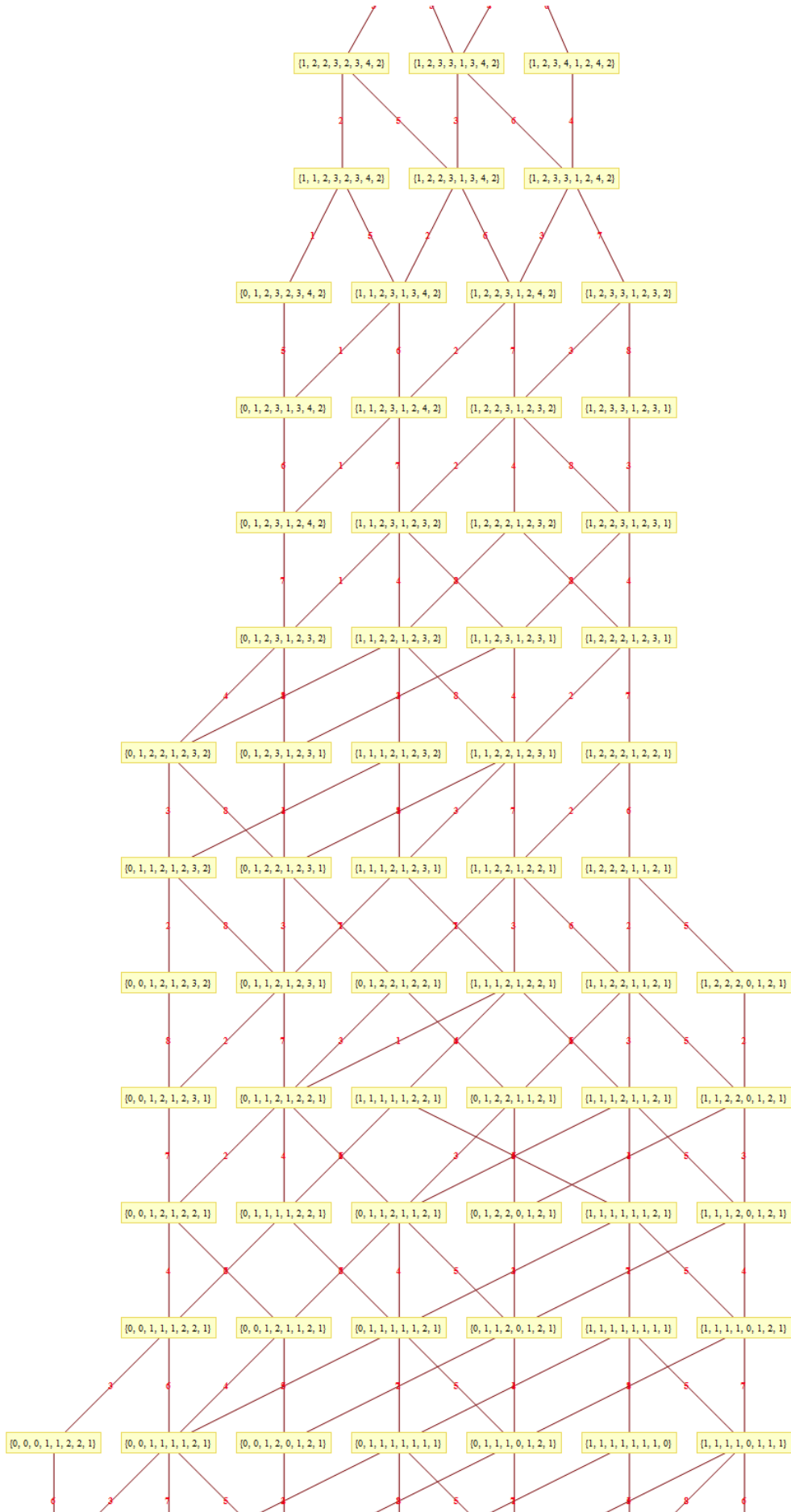

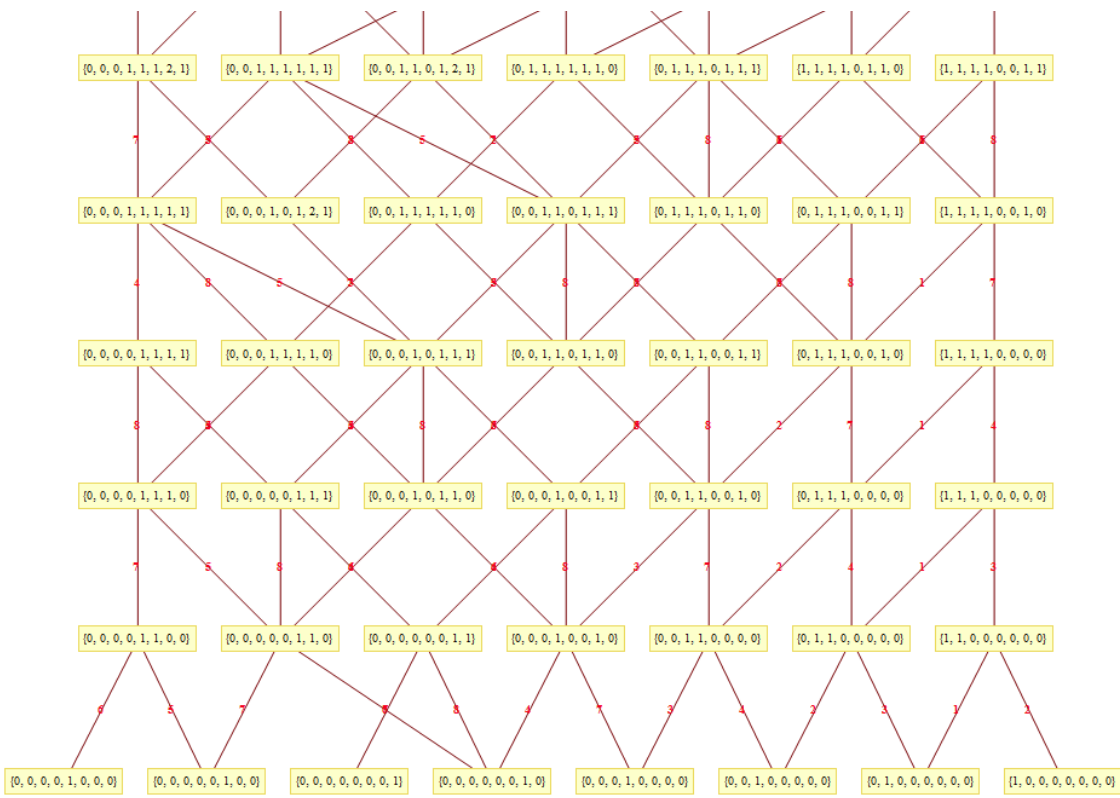

VIII. APPENDIX B

pascalRow=1

Seq #	Symbol	2D/3D Shape	Groups	Particle Quantum Bits	Binary / ES / Physics Coordinates	Algebra Root Weight / Height / Rft=Atomic Element Number -->	Ele #	Octonions
1	$\begin{matrix} \bar{x}_0 \\ \bar{x}_1 \\ \bar{x}_2 \\ \bar{x}_3 \\ \bar{x}_4 \\ \bar{x}_5 \\ \bar{x}_6 \\ \bar{x}_7 \\ \bar{x}_8 \\ \bar{x}_9 \end{matrix}$		{BC8, E7, E6, 6Cube, E5, E4, C4, H4, 24cell, 8Cell, altSnub24, snub24ER, 24cellH4, 3Cube, B2=C2, Hamming, Idempot}	0ppgsscc 00101100 ₂	Ba 0 0 0 0 0 0 0 0 0 0 ES -1 -1 -1 -1 -1 -1 -1 -1 -1 -1 Ph -1 -1 0 1 -1 -1 -1 0 0 0	Rt 0 0 0 0 1 0 0 0 0 Wt 0 0 0 0 2 -1 0 0 0 Hr 1	4	Flipped Triad fpi=7 BC ₈ # f _p _sm3=1BH (2, 4, 2), (1, 5, 3), (1, 6, 7), (2, 6, 3), (2, 7, 3), (3, 4, 7), (4, 5, 6), (2, 7, 4), (2, 6, 5), (3, 4, 5), (3, 6, 7) Not Flipped Triad fpi=4 BC ₈ # f _p _sm3=1BH (1, 3, 2), (1, 6, 4), (1, 5, 7), (2, 6, 3), (2, 7, 3), (3, 4, 7), (4, 5, 6), (2, 7, 4), (2, 6, 5), (3, 4, 5), (3, 6, 7) flat triad/mask bits {1, 2, 4, 5, 3, 6, 7} {1, 0, 1, 1, 0, 0}

pascalRow=2

2	$\begin{matrix} \bar{x}_0 \\ \bar{x}_1 \\ \bar{x}_2 \\ \bar{x}_3 \\ \bar{x}_4 \\ \bar{x}_5 \\ \bar{x}_6 \\ \bar{x}_7 \\ \bar{x}_8 \\ \bar{x}_9 \end{matrix}$		{8Ortho}	0ppgsscc 01000000 ₂	Ba 1 0 0 0 0 0 0 0 0 0 ES 0 0 0 0 0 0 0 0 0 0 Ph 0 0 0 0 0 0 1 -1 0 0	Rt 1 2 3 4 2 7 5 2 Wt 0 0 0 0 1 0 0 0 Hr 23	Exc	Flipped Invalid octonion Fano plane not defined!	Not Flipped Invalid octonion Fano plane not defined!
3	$\begin{matrix} \bar{x}_0 \\ \bar{x}_1 \\ \bar{x}_2 \\ \bar{x}_3 \\ \bar{x}_4 \\ \bar{x}_5 \\ \bar{x}_6 \\ \bar{x}_7 \\ \bar{x}_8 \\ \bar{x}_9 \end{matrix}$		{8Ortho}	0ppgsscc 01000100 ₂	Ba 0 1 0 0 0 0 0 0 0 0 ES 0 0 0 0 0 0 0 -1 0 0 Ph 0 0 0 0 0 0 1 -1 0 0	Rt 0 0 0 0 0 1 0 1 Wt 0 0 0 0 1 0 0 0 Hr 0	Exc	Flipped Invalid octonion Fano plane not defined!	Not Flipped Invalid octonion Fano plane not defined!
4	$\begin{matrix} \bar{x}_0 \\ \bar{x}_1 \\ \bar{x}_2 \\ \bar{x}_3 \\ \bar{x}_4 \\ \bar{x}_5 \\ \bar{x}_6 \\ \bar{x}_7 \\ \bar{x}_8 \\ \bar{x}_9 \end{matrix}$		{8Ortho}	0ppgsscc 01001000 ₂	Ba 0 0 0 1 0 0 0 0 0 0 ES 0 0 0 0 0 0 0 -1 0 0 Ph 0 0 0 0 0 0 1 -1 0 0	Rt 0 0 0 0 0 1 0 1 Wt 0 0 0 0 1 -1 0 0 Hr 1	Exc	Flipped Invalid octonion Fano plane not defined!	Not Flipped Invalid octonion Fano plane not defined!
5	$\begin{matrix} \bar{x}_0 \\ \bar{x}_1 \\ \bar{x}_2 \\ \bar{x}_3 \\ \bar{x}_4 \\ \bar{x}_5 \\ \bar{x}_6 \\ \bar{x}_7 \\ \bar{x}_8 \\ \bar{x}_9 \end{matrix}$		{8Ortho}	0ppgsscc 01001100 ₂	Ba 0 0 0 0 1 0 0 0 0 0 ES 0 0 0 0 0 0 -1 0 0 0 Ph 0 0 0 0 0 0 -1 0 0 0	Rt 0 0 0 0 0 1 -1 1 Wt 0 0 0 1 1 0 -1 0 Hr 2	Exc	Flipped Invalid octonion Fano plane not defined!	Not Flipped Invalid octonion Fano plane not defined!
6	$\begin{matrix} \bar{x}_0 \\ \bar{x}_1 \\ \bar{x}_2 \\ \bar{x}_3 \\ \bar{x}_4 \\ \bar{x}_5 \\ \bar{x}_6 \\ \bar{x}_7 \\ \bar{x}_8 \\ \bar{x}_9 \end{matrix}$		{8Ortho, 24cell, 16Cell}	0ppgsscc 01100000 ₂	Ba 0 0 0 0 0 1 0 0 0 0 ES 0 0 0 0 -1 0 0 0 0 0 Ph 0 0 0 1 -1 0 0 0 0 0	Rt 0 0 0 -1 0 1 -1 1 Wt 0 0 1 -1 1 0 0 0 Hr 3	Exc	Flipped Invalid octonion Fano plane not defined!	Not Flipped Invalid octonion Fano plane not defined!
7	$\begin{matrix} \bar{x}_0 \\ \bar{x}_1 \\ \bar{x}_2 \\ \bar{x}_3 \\ \bar{x}_4 \\ \bar{x}_5 \\ \bar{x}_6 \\ \bar{x}_7 \\ \bar{x}_8 \\ \bar{x}_9 \end{matrix}$		{8Ortho, 24cell, 16Cell}	0ppgsscc 01100100 ₂	Ba 0 0 0 0 0 0 1 0 0 0 ES 0 0 0 -1 0 0 0 0 0 0 Ph 0 0 0 1 -1 0 0 0 0 0	Rt 0 0 0 -1 -1 0 1 -1 Wt 0 1 -1 0 1 0 0 0 Hr 4	Exc	Flipped Invalid octonion Fano plane not defined!	Not Flipped Invalid octonion Fano plane not defined!
8	$\begin{matrix} \bar{x}_0 \\ \bar{x}_1 \\ \bar{x}_2 \\ \bar{x}_3 \\ \bar{x}_4 \\ \bar{x}_5 \\ \bar{x}_6 \\ \bar{x}_7 \\ \bar{x}_8 \\ \bar{x}_9 \end{matrix}$		{8Ortho, 24cell, 16Cell}	0ppgsscc 01101000 ₂	Ba 0 0 0 0 0 0 0 1 0 0 ES 0 0 -1 0 0 0 0 0 0 0 Ph 0 0 -1 0 0 0 0 0 0 0	Rt 0 -1 -1 -1 0 1 -1 1 Wt 1 -1 0 0 1 0 0 0 Hr 5	Exc	Flipped Invalid octonion Fano plane not defined!	Not Flipped Invalid octonion Fano plane not defined!
9	$\begin{matrix} \bar{x}_0 \\ \bar{x}_1 \\ \bar{x}_2 \\ \bar{x}_3 \\ \bar{x}_4 \\ \bar{x}_5 \\ \bar{x}_6 \\ \bar{x}_7 \\ \bar{x}_8 \\ \bar{x}_9 \end{matrix}$		{8Ortho, 24cell, 16Cell}	0ppgsscc 01101100 ₂	Ba 0 0 0 0 0 0 0 0 1 0 ES -1 0 0 0 0 0 0 0 0 0 Ph -1 0 0 0 0 0 0 0 0 0	Rt -1 -1 -1 -1 0 1 -1 1 Wt -1 0 0 0 1 0 0 0 Hr 6	Exc	Flipped Invalid octonion Fano plane not defined!	Not Flipped Invalid octonion Fano plane not defined!

pascalRow=3

10	$\begin{matrix} \bar{x}_0 \\ \bar{x}_1 \\ \bar{x}_2 \\ \bar{x}_3 \\ \bar{x}_4 \\ \bar{x}_5 \\ \bar{x}_6 \\ \bar{x}_7 \\ \bar{x}_8 \\ \bar{x}_9 \end{matrix}$		{BC8, E7, E6, 6Cube, E5, E4, C4, H4, 24cell, 8Cell, altSnub24, snub24ER, snub24H4, 3Cube, B2=C2}	0ppgsscc 001010000 ₂	Ba 1 1 0 0 0 0 0 0 0 0 ES 1 1 1 1 1 1 1 1 1 1 Ph 2 2 2 2 2 2 2 2 2 2	Rt 1 2 2 2 2 1 1 2 1 Wt 0 1 0 0 0 1 -1 0 0 Hr 12	Au 79	Flipped Triad fpi=7 BC ₈ # f _p _sm3=05H (1, 4, 2), (1, 3, 5), (1, 7, 6), (2, 3, 6), (2, 5, 7), (3, 4, 7), (4, 5, 6), (2, 7, 4), (2, 6, 5), (3, 4, 5), (3, 6, 7) Not Flipped Triad fpi=4 BC ₈ # f _p _sm3=05H (1, 3, 2), (1, 4, 6), (1, 7, 5), (2, 6, 3), (2, 7, 3), (3, 4, 7), (4, 5, 6), (2, 7, 4), (2, 6, 5), (3, 4, 5), (3, 6, 7) flat triad/mask bits {1, 2, 4, 3, 5, 7, 6} {1, 0, 1, 0, 0, 0, 0}
11	$\begin{matrix} \bar{x}_0 \\ \bar{x}_1 \\ \bar{x}_2 \\ \bar{x}_3 \\ \bar{x}_4 \\ \bar{x}_5 \\ \bar{x}_6 \\ \bar{x}_7 \\ \bar{x}_8 \\ \bar{x}_9 \end{matrix}$		{BC8, E7, E6, 6Cube, E5, E4, C4, H4, 24cell, 8Cell, altSnub24, snub24ER, snub24H4, 3Cube, B2=C2}	0ppgsscc 001011100 ₂	Ba 1 0 1 0 0 0 0 0 0 0 ES 1 1 1 1 1 1 1 1 1 1 Ph 2 2 2 2 2 2 2 2 2 2	Rt 1 1 2 2 2 1 1 2 1 Wt 1 -1 1 0 1 -1 0 0 Hr 11	Ta 73	Flipped Triad fpi=7 BC ₈ # f _p _sm3=36H (1, 2, 4), (1, 5, 3), (1, 7, 6), (2, 3, 6), (2, 5, 7), (3, 4, 7), (4, 5, 6), (2, 7, 4), (2, 6, 5), (3, 4, 5), (3, 6, 7) Not Flipped Triad fpi=4 BC ₈ # f _p _sm3=36H (1, 2, 3), (1, 6, 4), (1, 7, 5), (2, 6, 3), (2, 7, 3), (3, 4, 7), (4, 5, 6), (2, 7, 4), (2, 6, 5), (3, 4, 5), (3, 6, 7) flat triad/mask bits {1, 2, 4, 3, 5, 7, 6} {0, 1, 0, 1, 1, 0}
12	$\begin{matrix} \bar{x}_0 \\ \bar{x}_1 \\ \bar{x}_2 \\ \bar{x}_3 \\ \bar{x}_4 \\ \bar{x}_5 \\ \bar{x}_6 \\ \bar{x}_7 \\ \bar{x}_8 \\ \bar{x}_9 \end{matrix}$		{BC8, E7, E6, 6Cube, E5, C4, H4, 24cell, 8Cell, altSnub24, snub24ER, snub24H4, 3Cube}	0ppgsscc 000111100 ₂	Ba 1 0 0 1 0 0 0 0 0 0 ES 1 1 1 1 1 1 1 1 1 1 Ph 2 2 2 2 2 2 2 2 2 2	Rt 1 1 1 2 1 1 2 1 Wt 1 0 -1 1 1 -1 0 0 Hr 10	Ho 67	Flipped Triad fpi=4 BC ₈ # f _p _sm3=31H (1, 3, 2), (1, 4, 6), (1, 5, 7), (2, 4, 7), (2, 6, 5), (3, 5, 6), (3, 6, 7), (2, 7, 5), (3, 7, 4), (4, 5, 6), (2, 7, 4), (2, 6, 5), (3, 4, 5), (3, 6, 7) Not Flipped Triad fpi=7 BC ₈ # f _p _sm3=31H (1, 4, 2), (1, 3, 5), (1, 6, 7), (2, 4, 7), (2, 6, 5), (3, 5, 6), (3, 6, 7), (2, 7, 5), (3, 7, 4), (4, 5, 6), (2, 7, 4), (2, 6, 5), (3, 4, 5), (3, 6, 7) flat triad/mask bits {1, 2, 3, 4, 5, 7, 6} {1, 0, 0, 0, 1, 1, 0}



13	$\frac{1}{\sqrt{2}} \frac{b}{a} \frac{L}{L}$		{BCR, E7, E6, 6Cube, C4, H4, 24cell, 8Cell, altSub24, snub24ER, 24cellH4}	0apggsscc 01011000 ₂	Ba) 1 0 0 0 0 1 0 0 0 1 ER) 1 1 1 1 1 1 1 1 1 1 Ph) 1 1 1 1 1 1 1 1 1 1			Flipped Triad fpi=23 BC ₂ # fp_smm2=7EH	Not Flipped Triad fpi=24 BC ₂ # fp_smm3=7DH	Rr) 1 1 1 1 1 1 1 1 1 1 2 1 Wf) 1 0 0 0 -1 1 -1 1 0 0 1 Hr 9	Pm 61 flat triad/mask bits [1, 6, 2, 7, 3, 5, 4] [0, 1, 1, 1, 1, 1, 1]
14	$\frac{1}{\sqrt{2}} \frac{b}{a} \frac{L}{L}$		{BCR, E7, 6Cube, C4, H4, dualSub24, 24cellE8, 24cellE8, snub24H4}	0apggsscc 01011000 ₂	Ba) 1 0 0 0 0 0 1 0 0 1 ER) 1 1 1 1 1 1 1 1 1 1 Ph) 1 1 1 1 1 1 1 1 1 1			Flipped Triad fpi=26 BC ₂ # fp_smm8=74H	Not Flipped Triad fpi=25 BC ₂ # fp_smm5=77H	Rr) 1 1 1 1 1 1 1 1 1 1 1 Wf) 1 0 0 0 0 1 0 0 -1 1 1 Hr 8	Ba 56 flat triad/mask bits [1, 7, 2, 3, 4, 6, 5] [0, 0, 1, 0, 1, 1, 1]
15	$\frac{1}{\sqrt{2}} \frac{b}{a} \frac{L}{L}$		{BCR, 6Cube, H4, dualSub24, 24cellE8, snub24H4}	0apggsscc 01011001 ₂	Ba) 1 0 0 0 0 0 0 1 0 1 ER) 1 1 1 1 1 1 1 1 1 1 Ph) 1 1 1 1 1 1 1 1 1 1			Flipped Triad fpi=29 BC ₂ # fp_smm7=75H	Not Flipped Triad fpi=27 BC ₂ # fp_smm4=7CH	Rr) 1 1 1 1 1 1 1 1 1 0 0 Wf) 1 0 0 0 0 1 0 0 -1 1 1 Hr 7	Sn 50 flat triad/mask bits [1, 2, 7, 3, 6, 5, 4] [0, 0, 1, 1, 1, 1, 1]
16	$\frac{1}{\sqrt{2}} \frac{b}{a} \frac{L}{L}$		{BCR, H4, dualSub24, 24cellE8, snub24H4}	0apggsscc 01011001 ₂	Ba) 1 0 0 0 0 0 0 0 1 1 ER) 1 1 1 1 1 1 1 1 1 1 Ph) 1 1 1 1 1 1 1 1 1 1			Flipped Triad fpi=28 BC ₂ # fp_smm3=7DH	Not Flipped Triad fpi=30 BC ₂ # fp_smm6=76H	Rr) 0 -1 -2 -3 -1 -3 -4 -2 1 Wf) 1 0 0 0 0 1 -1 0 0 0 1 Hr 16	Np 93 flat triad/mask bits [1, 7, 2, 3, 6, 5, 4] [0, 1, 1, 1, 1, 1, 1]
17	$\frac{0}{\sqrt{2}} \frac{b}{a} \frac{L}{L}$		{BCR, E7, E6, 6Cube, E5, E4, C4, H4, 24cell, 8Cell, altSub24, cellER, snub24H4, 3Cube, B2=C2}	0apggsscc 00101100 ₂	Ba) 0 1 1 1 0 0 0 0 0 0 ER) 1 1 1 1 1 1 1 1 1 1 Ph) 1 1 1 1 1 1 1 1 1 1			Flipped Triad fpi=7 BC ₂ # fp_smm3=28H	Not Flipped Triad fpi=4 BC ₂ # fp_smm3=28H	Rr) 0 1 2 2 2 1 1 2 1 1 Wf) -1 0 1 0 1 1 -1 0 0 0 1 Hr 10	Tb 65 flat triad/mask bits [1, 4, 2, 3, 6, 5, 7] [0, 0, 0, 1, 0, 1, 0]
18	$\frac{e}{\sqrt{2}} \frac{b}{a} \frac{L}{L}$		{BCR, E7, E6, 6Cube, E5, C4, H4, 24cell, 8Cell, altSub24, snub24ER, snub24H4, 3Cube}	0apggsscc 00001100 ₂	Ba) 0 1 1 1 1 0 0 0 0 1 ER) 1 1 1 1 1 1 1 1 1 1 Ph) 1 1 1 1 1 1 1 1 1 1			Flipped Triad fpi=4 BC ₂ # fp_smm3=2FH	Not Flipped Triad fpi=7 BC ₂ # fp_smm3=2FH	Rr) 0 1 1 2 2 1 1 2 1 1 Wf) -1 -1 -1 1 1 -1 0 0 0 1 Hr 9	Pr 59 flat triad/mask bits [1, 2, 3, 6, 4, 7, 5] [1, 1, 1, 1, 0, 1, 0]
19	$\frac{1}{\sqrt{2}} \frac{b}{a} \frac{L}{L}$		{BCR, E7, E6, 6Cube, C4, H4, 24cell, 8Cell, altSub24, snub24ER, snub24H4}	0apggsscc 01011010 ₂	Ba) 0 1 1 0 0 0 1 0 0 0 ER) 1 1 1 1 1 1 1 1 1 1 Ph) 1 1 1 1 1 1 1 1 1 1			Flipped Triad fpi=23 BC ₂ # fp_smm2=60H	Not Flipped Triad fpi=24 BC ₂ # fp_smm3=63H	Rr) 0 1 1 1 1 1 1 1 1 2 1 Wf) -1 1 0 -1 1 -1 1 0 0 1 Hr 8	I 53 flat triad/mask bits [1, 6, 2, 3, 7, 4, 5] [0, 0, 0, 0, 1, 1]
20	$\frac{1}{\sqrt{2}} \frac{b}{a} \frac{L}{L}$		{BCR, E7, 6Cube, C4, H4, snub24, altSub24, snub24ER, 24cellH4}	0apggsscc 01011010 ₂	Ba) 0 1 1 0 0 0 1 0 0 0 ER) 1 1 1 1 1 1 1 1 1 1 Ph) 1 1 1 1 1 1 1 1 1 1			Flipped Triad fpi=26 BC ₂ # fp_smm8=6AH	Not Flipped Triad fpi=25 BC ₂ # fp_smm5=69H	Rr) 0 1 1 1 1 1 1 1 1 1 1 Wf) -1 1 0 0 1 0 0 -1 1 1 Hr 7	Cd 48 flat triad/mask bits [1, 7, 2, 4, 3, 5, 6] [0, 1, 0, 1, 0, 1, 1]
21	$\frac{1}{\sqrt{2}} \frac{b}{a} \frac{L}{L}$		{BCR, 6Cube, H4, dualSub24, snub24H4}	0apggsscc 01011011 ₂	Ba) 0 1 1 0 0 0 0 1 0 0 ER) 1 1 1 1 1 1 1 1 1 1 Ph) 1 1 1 1 1 1 1 1 1 1			Flipped Triad fpi=29 BC ₂ # fp_smm7=6BH	Not Flipped Triad fpi=27 BC ₂ # fp_smm4=62H	Rr) 0 1 1 1 1 1 1 1 1 0 0 Wf) -1 1 0 0 1 0 0 -1 1 1 Hr 6	Nb 41 flat triad/mask bits [1, 2, 7, 6, 3, 4, 5] [1, 1, 0, 1, 0, 1, 1]
22	$\frac{1}{\sqrt{2}} \frac{b}{a} \frac{L}{L}$		{BCR, H4, snub24, altSub24, cellER, snub24H4}	0apggsscc 01011011 ₂	Ba) 0 1 1 1 1 0 0 0 0 1 ER) 1 1 1 1 1 1 1 1 1 1 Ph) 1 1 1 1 1 1 1 1 1 1			Flipped Triad fpi=28 BC ₂ # fp_smm3=63H	Not Flipped Triad fpi=30 BC ₂ # fp_smm6=68H	Rr) -1 -1 -2 -3 -1 -3 -4 -2 1 Wf) -1 1 0 0 1 1 -1 0 0 0 1 Hr 17	CF 98 flat triad/mask bits [1, 7, 2, 5, 3, 4, 6] [1, 1, 0, 0, 1, 1]
23	$\frac{e}{\sqrt{2}} \frac{b}{a} \frac{L}{L}$		{BCR, E7, E6, 6Cube, E5, C4, H4, 24cell, 8Cell, altSub24, snub24ER, snub24H4, 3Cube}	0apggsscc 00001100 ₂	Ba) 0 0 1 1 1 0 0 0 0 0 ER) 1 1 1 1 1 1 1 1 1 1 Ph) 1 1 1 1 1 1 1 1 1 1			Flipped Triad fpi=4 BC ₂ # fp_smm3=1CH	Not Flipped Triad fpi=7 BC ₂ # fp_smm3=1CH	Rr) 0 0 1 2 2 1 1 2 1 1 Wf) 0 -1 0 1 1 -1 0 0 0 1 Hr 8	Te 52 flat triad/mask bits [1, 3, 2, 4, 6, 7, 5] [0, 0, 1, 1, 1, 0, 0]
24	$\frac{1}{\sqrt{2}} \frac{b}{a} \frac{L}{L}$		{BCR, E7, E6, 6Cube, C4, H4, 24cell, 8Cell, altSub24, snub24ER, snub24H4}	0apggsscc 01011100 ₂	Ba) 0 0 1 0 0 1 0 0 0 0 ER) 1 1 1 1 1 1 1 1 1 1 Ph) 1 1 1 1 1 1 1 1 1 1			Flipped Triad fpi=23 BC ₂ # fp_smm2=53H	Not Flipped Triad fpi=24 BC ₂ # fp_smm3=50H	Rr) 0 0 1 1 1 1 1 1 2 1 1 Wf) 0 -1 1 -1 1 -1 1 0 0 1 Hr 7	Rh 45 flat triad/mask bits [1, 2, 6, 7, 3, 4, 5] [1, 1, 0, 0, 1, 0, 1]
25	$\frac{1}{\sqrt{2}} \frac{b}{a} \frac{L}{L}$		{BCR, E7, 6Cube, C4, H4, snub24, altSub24, snub24ER, snub24H4}	0apggsscc 01011100 ₂	Ba) 0 0 1 0 1 0 0 1 0 0 ER) 1 1 1 1 1 1 1 1 1 1 Ph) 1 1 1 1 1 1 1 1 1 1			Flipped Triad fpi=26 BC ₂ # fp_smm8=59H	Not Flipped Triad fpi=25 BC ₂ # fp_smm5=5AH	Rr) 0 0 0 1 1 1 1 1 1 1 1 Wf) 0 -1 1 0 1 0 0 -1 1 1 Hr 6	Y 39 flat triad/mask bits [1, 2, 7, 3, 4, 5, 6] [0, 0, 0, 1, 1, 0, 1]
26	$\frac{1}{\sqrt{2}} \frac{b}{a} \frac{L}{L}$		{BCR, 6Cube, H4, snub24, altSub24, snub24ER, 24cellH4}	0apggsscc 01011101 ₂	Ba) 0 0 1 0 0 0 0 1 0 0 ER) 1 1 1 1 1 1 1 1 1 1 Ph) 1 1 1 1 1 1 1 1 1 1			Flipped Triad fpi=29 BC ₂ # fp_smm7=58H	Not Flipped Triad fpi=27 BC ₂ # fp_smm4=51H	Rr) 0 0 1 1 1 1 1 1 1 0 0 Wf) 0 -1 1 0 1 0 0 -1 1 1 Hr 5	As 33 flat triad/mask bits [1, 7, 2, 3, 6, 5, 4] [0, 0, 0, 1, 1, 0, 1]

27		{BCR, H40, dualSub24, snub24H40}	0apggssc 01011101 ₂	Ba[0 0 0 1 0 0 0 0 1] ER[1 1 1 1 1 1 1 1] Ph[1 1 1 0 1 1 1 1]	R[-1 -2 -2 -3 -1 -3 -4 -2] W[0 -1 1 0 1 -1 0 0] Hr 18	Flipped Triad spin=23 BC ₂ # fp ₂ sm=3+50H Not Flipped Triad spin=30 BC ₂ # fp ₂ sm=6+5BH [1, 2, 7], (1, 3, 5), (1, 4, 6), (1, 7, 2), (1, 6, 3), (1, 4, 5), (2, 3, 6), (2, 5, 4), (3, 4, 7), (5, 7, 6)[2, 5, 3], (2, 6, 4), (3, 4, 7), (5, 7, 6)
28		{BCR, E7, E6, 6Cube, C4, H4, 24cell, 8Cell, altSub24, snub24E8, snub24H4}	0apggssc 010111100 ₂	Ba[0 0 0 0 1 1 0 0 0] ER[1 1 1 1 1 1 1 1] Ph[1 1 1 0 1 1 1 1]	R[0 0 0 0 1 1 1 2] W[0 0 0 -1 0 1 -1 1] Hr 6	Flipped Triad spin=23 BC ₂ # fp ₂ sm=2+4DH Not Flipped Triad spin=24 BC ₂ # fp ₂ sm=3+4EH [1, 2, 7], (1, 3, 7), (1, 5, 4), (1, 2, 6), (1, 7, 3), (1, 5, 4), (2, 4, 3), (2, 5, 7), (3, 5, 6), (4, 7, 6)[2, 5, 3], (2, 4, 7), (3, 4, 6), (5, 7, 6)
29		{BCR, E7, 6Cube, C4, H40, dualSub24, snub24E8, snub24H4}	0apggssc 010111101 ₂	Ba[0 0 0 0 1 0 1 0 0] ER[1 1 1 1 1 1 1 1] Ph[1 1 1 0 1 1 1 1]	R[0 0 0 0 1 1 1 1] W[0 0 0 -1 1 1 0 0] Hr 5	Flipped Triad spin=26 BC ₂ # fp ₂ sm=8+7H Not Flipped Triad spin=25 BC ₂ # fp ₂ sm=5+4HH [1, 2, 7], (1, 4, 3), (1, 6, 5), (1, 2, 6), (1, 3, 4), (1, 6, 5), (2, 3, 6), (2, 4, 5), (3, 5, 7), (4, 7, 6)[2, 3, 5], (2, 4, 6), (3, 6, 7), (4, 7, 6)
30		{BCR, 6Cube, H4, snub24, altSub24, snub24E8, snub24H4}	0apggssc 010111110 ₂	Ba[0 0 0 0 1 0 0 1 0] ER[1 1 1 1 1 1 1 1] Ph[1 1 1 0 1 1 1 1]	R[0 0 0 0 1 1 1 1] W[0 0 0 -1 1 1 0 0] Hr 4	Flipped Triad spin=26 BC ₂ # fp ₂ sm=8+7H Not Flipped Triad spin=27 BC ₂ # fp ₂ sm=4+4HH [1, 2, 7], (1, 6, 3), (1, 5, 4), (1, 7, 2), (1, 3, 6), (1, 6, 4), (2, 3, 4), (2, 5, 6), (3, 5, 7), (4, 7, 6)[2, 4, 3], (2, 6, 5), (3, 6, 7), (4, 7, 6)
31		{BCR, H4, snub24, altSub24, cellE8, 24cellH4}	0apggssc 010111111 ₂	Ba[0 0 0 0 1 0 0 0 1] ER[1 1 1 1 1 1 1 1] Ph[1 1 1 0 1 1 1 1]	R[-1 -2 -3 -3 -1 -3 -4 -2] W[0 0 0 -1 1 1 -1 0] Hr 19	Flipped Triad spin=28 BC ₂ # fp ₂ sm=3+4EH Not Flipped Triad spin=30 BC ₂ # fp ₂ sm=6+4SH [1, 2, 7], (1, 6, 3), (1, 4, 6), (1, 7, 2), (1, 3, 4), (1, 6, 5), (2, 6, 3), (2, 4, 5), (3, 4, 7), (5, 7, 6)[2, 3, 5], (2, 6, 4), (3, 4, 7), (5, 7, 6)
32		{BCR, E7, 6Cube, C4, H40, dualSub24, 24cellE8, snub24H4}	0apggssc 01010001 ₂	Ba[0 0 0 0 1 1 0 0 0] ER[1 1 1 1 1 1 1 1] Ph[1 1 1 0 1 1 1 1]	R[0 0 0 0 1 1 1 1] W[0 0 0 -1 1 0 0 1] Hr 4	Flipped Triad spin=10 BC ₂ # fp ₂ sm=3+77H Not Flipped Triad spin=8 BC ₂ # fp ₂ sm=2+7EH [1, 4, 2], (1, 6, 3), (1, 5, 7), (1, 2, 4), (1, 3, 4), (1, 6, 5), (2, 3, 7), (2, 6, 5), (3, 5, 4), (4, 7, 6)[2, 7, 3], (2, 6, 5), (3, 6, 4), (4, 7, 6)
33		{BCR, 6Cube, H40, dualSub24, 24cellE8, snub24H4}	0apggssc 01010010 ₂	Ba[0 0 0 0 1 0 1 0 0] ER[1 1 1 1 1 1 1 1] Ph[1 1 1 0 1 1 1 1]	R[0 0 0 0 1 1 1 1] W[0 0 0 -1 1 0 1 -1] Hr 3	Flipped Triad spin=12 BC ₂ # fp ₂ sm=4+7CH Not Flipped Triad spin=11 BC ₂ # fp ₂ sm=1+7FH [1, 2, 4], (1, 3, 7), (1, 5, 6), (1, 2, 4), (1, 3, 4), (1, 6, 5), (2, 6, 3), (2, 7, 5), (3, 5, 4), (4, 7, 6)[2, 5, 3], (2, 7, 6), (3, 6, 4), (4, 7, 6)
34		{BCR, H40, dualSub24, 24cellE8, snub24H4}	0apggssc 01001001 ₂	Ba[0 0 0 0 1 0 0 1 0] ER[1 1 1 1 1 1 1 1] Ph[1 1 1 0 1 1 1 1]	R[-1 -2 -3 -4 -1 -3 -4 -2] W[0 0 0 -1 1 -1 1 0] Hr 20	Flipped Triad spin=13 BC ₂ # fp ₂ sm=6+76H Not Flipped Triad spin=14 BC ₂ # fp ₂ sm=7+5SH [1, 2, 5], (1, 4, 3), (1, 7, 6), (1, 5, 2), (1, 3, 4), (1, 7, 6), (2, 3, 6), (2, 7, 4), (3, 7, 5), (4, 6, 5)[2, 3, 7], (2, 6, 4), (3, 6, 5), (4, 7, 6)
35		{BCR, 6Cube, H40, dualSub24, 24cellE8, snub24H4}	0apggssc 01010101 ₂	Ba[0 0 0 0 1 1 0 0 1] ER[1 1 1 1 1 1 1 1] Ph[1 1 1 0 1 1 1 1]	R[0 0 0 0 1 1 1 0] W[0 0 0 0 1 1 -1 0] Hr 2	Flipped Triad spin=13 BC ₂ # fp ₂ sm=6+10H Not Flipped Triad spin=14 BC ₂ # fp ₂ sm=7+13H [1, 2, 5], (1, 3, 4), (1, 6, 7), (1, 5, 2), (1, 3, 4), (1, 6, 7), (2, 3, 6), (2, 7, 4), (3, 5, 7), (4, 5, 6)[2, 3, 7], (2, 6, 4), (3, 6, 5), (4, 5, 6)
36		{BCR, H40, dualSub24, 24cellE8, snub24H4}	0apggssc 00101010 ₂	Ba[0 0 0 0 1 0 0 1 0] ER[1 1 1 1 1 1 1 1] Ph[1 1 1 0 1 1 1 1]	R[-1 -2 -3 -4 -1 -3 -5 -2] W[0 0 0 0 1 0 -1 1] Hr 21	Flipped Triad spin=12 BC ₂ # fp ₂ sm=4+1AH Not Flipped Triad spin=11 BC ₂ # fp ₂ sm=1+19H [1, 2, 4], (1, 7, 3), (1, 5, 6), (1, 2, 4), (1, 3, 4), (1, 6, 5), (2, 6, 3), (2, 7, 5), (3, 4, 5), (4, 6, 7)[2, 5, 3], (2, 7, 6), (3, 6, 4), (4, 5, 6)
37		{BCR, E7, H40, dualSub24, 24cellE8, snub24H4}	0apggssc 00101011 ₂	Ba[0 0 0 0 1 0 0 1 0] ER[1 1 1 1 1 1 1 1] Ph[1 1 1 0 1 1 1 1]	R[-1 -2 -3 -4 -1 -3 -5 -3] W[0 0 0 0 1 0 0 -1] Hr 22	Flipped Triad spin=10 BC ₂ # fp ₂ sm=5+11H Not Flipped Triad spin=8 BC ₂ # fp ₂ sm=2+18H [1, 4, 2], (1, 3, 6), (1, 5, 7), (1, 2, 4), (1, 3, 3), (1, 6, 7), (2, 3, 7), (2, 6, 5), (3, 4, 5), (4, 6, 7)[2, 7, 3], (2, 6, 5), (3, 4, 6), (4, 5, 6)

pascalRow#4

Seq #	Symbol	2D/3D Shape	Groups	Particle Quantum Bits	Binary / ER / Physics Coordinates	Algebra Root Weight / Height / RZ/Atomic Element Number -->	Elc #	Octonions
38			{D8, E7, D7, E6, D6, E5, D5, E4, D4, F4, H40, snub24H40, D3, D3, D2}	0apggssc 01100111 ₂	Ba[1 1 1 0 0 0 0 0] ER[-1 -1 0 0 0 0 0 0] Ph[-1 -1 0 0 0 0 0 0]	R[-1 -2 -2 -2 -1 -2 -1] W[0 -1 0 0 1 0 0 0] Hr 11	Flipped Triad spin=6 D ₈ # fp ₂ sm=6+42H Not Flipped Triad spin=9 D ₈ # fp ₂ sm=6+42H [1, 2, 3], (1, 7, 4), (1, 5, 6), [1, 2, 4], (1, 3, 7), (1, 5, 6), (2, 4, 6), (2, 5, 7), (3, 4, 5), (4, 6, 7)[2, 3, 5], (2, 6, 7), (3, 4, 7), (4, 5, 6)	
39			{D8, E7, D7, E6, D6, E5, D5, E4, D4, F4, H40, snub24H40, D3, D3}	0apggssc 01100101 ₂	Ba[1 1 0 1 0 0 0 0] ER[-1 0 -1 0 0 0 0 0] Ph[-1 0 1 1 0 0 0 0]	R[-1 -1 -2 -2 0 -1 -2 -1] W[-1 1 -1 0 1 0 0 0] Hr 10	Flipped Triad spin=1 D ₈ # fp ₂ sm=5+50H Not Flipped Triad spin=2 D ₈ # fp ₂ sm=8+5EH [1, 3, 2], (1, 4, 5), (1, 7, 6), [1, 2, 4], (1, 5, 4), (1, 7, 6), (2, 6, 4), (2, 7, 5), (3, 4, 7), (3, 6, 5)[2, 7, 4], (2, 6, 5), (3, 4, 6), (3, 7, 6)	

54	$\frac{\sqrt{3}}{2} \times \frac{1}{\sqrt{3}}$ Ym L		{D8, E7, D7, E6, D6, D5, H4, snub24, abSub24, snub24ER, snub24H4}	0ppgssc 01010100 ₂	Bnf E8f Phi	1 0 0	0 -1 -1	0 0 0	0 -1 0	0 0 0	1 -1 -1	0 0 0	1 0 0	0 0 0	1 0 0	Rf Wf Ht	0 -1 7	-1 -1 0	-1 1 0	-1 0 0	-1 -1 0	47	Flipped Triad spin: 15 D ₈ R ₈ fp ₂ sm3-50H (1, 2, 3), (1, 3, 6), (1, 4, 7), (2, 3, 4), (2, 7, 4), (3, 5, 7), (4, 5, 5) [2, 3, 7], (2, 6, 4), (3, 4, 5), (5, 7)	Not Flipped Triad spin: 16 D ₈ R ₈ fp ₂ sm3-50H (1, 2, 5), (1, 3, 6), (1, 4, 7), (2, 6, 4), (3, 4, 5), (5, 7)	flat triad/mask bits [1, 5, 2, 3, 4, 7] [0, 0, 0, 0, 1, 0, 1]	flat triad/mask bits [1, 2, 5, 3, 6, 4, 7] [0, 0, 0, 0, 1, 0, 1]	
55	$\frac{c}{2/3} \times \frac{2/3}{r_m}$		{D8, E7, D7, D6, H4, snub24, abSub24, snub24ER, 24cellH4, 16cellH4}	0ppgssc 00110101 ₂	Bnf E8f Phi	1 0 0	0 -1 0	0 0 0	0 0 0	1 -1 0	0 0 0	1 1 1	0 -1 1	0 0 0	1 0 0	Rf Wf Ht	0 -1 6	-1 -1 0	-1 1 -1	-1 -1 -1	-1 -1 -1	40	Flipped Triad spin: 19 D ₈ R ₈ fp ₂ sm3-36H (1, 2, 6), (1, 4, 3), (1, 7, 5), (2, 3, 5), (2, 7, 4), (3, 7, 6), (4, 5, 6) [2, 4, 3], (2, 7, 4), (3, 6, 5), (4, 5)	Not Flipped Triad spin: 17 D ₈ R ₈ fp ₂ sm3-36H (1, 5, 2), (1, 3, 7), (1, 6, 4), (2, 3, 5), (2, 7, 4), (3, 7, 6), (4, 5, 6) [2, 4, 3], (2, 7, 4), (3, 6, 5), (4, 5)	flat triad/mask bits [1, 6, 2, 4, 3, 7, 5] [0, 1, 1, 0, 1, 1, 0]	flat triad/mask bits [1, 5, 2, 7, 3, 6, 4] [1, 1, 1, 1, 1, 1, 0]	
56	$\frac{c}{2/3} \times \frac{2/3}{r_m}$		{D8, D7, H4a, dualSnub24, snub24H4a}	0ppgssc 00110110 ₂	Bnf E8f Phi	1 0 0	0 -1 0	0 0 0	0 0 0	1 -1 0	0 -1 0	0 0 0	1 -1 1	0 0 0	1 0 0	Rf Wf Ht	0 -1 5	-1 -1 0	-1 1 1	-1 -1 -1	-1 -1 -1	35	Flipped Triad spin: 20 D ₈ R ₈ fp ₂ sm1-34H (1, 2, 6), (1, 3, 4), (1, 7, 4), (2, 3, 7), (2, 5, 4), (3, 6, 5), (4, 5, 6) [2, 6, 3], (2, 7, 4), (3, 5, 4), (5, 6)	Not Flipped Triad spin: 18 D ₈ R ₈ fp ₂ sm6-2DH (1, 5, 2), (1, 3, 7), (1, 6, 4), (2, 3, 7), (2, 5, 4), (3, 5, 4), (5, 6)	flat triad/mask bits [1, 6, 2, 3, 4, 7, 5] [0, 0, 1, 0, 1, 1, 0]	flat triad/mask bits [1, 5, 2, 7, 3, 6, 4] [1, 0, 1, 1, 1, 1, 0]	
57	$\frac{c}{2/3} \times \frac{2/3}{r_m}$		{D8, H4, snub24, abSub24, 16cellER, snub24H4}	0ppgssc 00110111 ₂	Bnf E8f Phi	1 0 0	0 -1 0	0 0 0	0 0 0	1 0 0	1 -1 0	0 0 0	1 -1 1	0 0 -1	0 0 0	Rf Wf Ht	1 -1 18	1 -1 0	2 0 0	2 1 0	3 4 2	2 1	101	Flipped Triad spin: 21 D ₈ R ₈ fp ₂ sm6-3DH (1, 6, 2), (1, 3, 5), (1, 7, 4), (2, 4, 3), (2, 7, 5), (3, 7, 6), (4, 5, 6) [2, 7, 3], (2, 7, 4), (3, 6, 4), (5, 6)	Not Flipped Triad spin: 22 D ₈ R ₈ fp ₂ sm6-3DH (1, 5, 2), (1, 3, 7), (1, 6, 4), (2, 4, 3), (2, 7, 5), (3, 7, 6), (4, 5, 6) [2, 7, 3], (2, 7, 4), (3, 6, 4), (5, 6)	flat triad/mask bits [1, 2, 6, 3, 5, 7, 4] [1, 0, 1, 1, 1, 1, 0]	flat triad/mask bits [1, 6, 2, 3, 5, 7, 4] [1, 0, 1, 1, 1, 1, 0]
58	$\frac{1}{m} \times \frac{1/3}{m}$		{D8, H4a, dualSnub24, 24cellER8, 16cellER8, snub24H4a}	0ppgssc 01010101 ₂	Bnf E8f Phi	1 0 0	0 -1 0	0 0 0	0 0 0	0 0 0	1 0 1	0 0 1	0 0 1	0 0 1	0 0 1	Rf Wf Ht	-1 -1 28	-3 -4 0	-5 -2 0	-4 -6 -3	-3 -3	119	Flipped Triad spin: 21 D ₈ R ₈ fp ₂ sm6-5BH (1, 2, 6), (1, 3, 4), (1, 7, 4), (2, 4, 3), (2, 7, 5), (3, 7, 6), (4, 5, 6) [2, 7, 3], (2, 7, 4), (3, 6, 4), (5, 7)	Not Flipped Triad spin: 22 D ₈ R ₈ fp ₂ sm6-5BH (1, 5, 2), (1, 3, 7), (1, 6, 4), (2, 4, 3), (2, 7, 5), (3, 7, 6), (4, 5, 6) [2, 7, 3], (2, 7, 4), (3, 6, 4), (5, 7)	flat triad/mask bits [1, 2, 6, 5, 3, 4, 7] [1, 0, 1, 1, 1, 0, 1]	flat triad/mask bits [1, 6, 2, 5, 3, 4, 7] [1, 0, 1, 1, 1, 0, 1]	
59	$\frac{1}{r_m} \times \frac{1/3}{r_m}$		{D8, D7, H4, snub24, abSub24, snub24ER, snub24H4}	0ppgssc 01010101 ₂	Bnf E8f Phi	0 1 0	1 -1 0	1 0 0	1 0 0	0 0 0	0 0 0	0 0 0	1 1 1	0 0 -1	0 0 0	Rf Wf Ht	0 -1 5	-1 -1 0	-1 0 0	-1 -1 0	-1 -1	34	Flipped Triad spin: 20 D ₈ R ₈ fp ₂ sm1-52H (1, 2, 6), (1, 4, 3), (1, 7, 4), (2, 3, 7), (2, 5, 4), (3, 5, 6), (4, 5, 6) [2, 6, 3], (2, 7, 4), (3, 4, 5), (5, 7)	Not Flipped Triad spin: 18 D ₈ R ₈ fp ₂ sm6-5BH (1, 5, 2), (1, 3, 7), (1, 6, 4), (2, 3, 7), (2, 5, 4), (3, 5, 6), (4, 5, 6) [2, 6, 3], (2, 7, 4), (3, 4, 5), (5, 7)	flat triad/mask bits [1, 6, 2, 4, 3, 5, 7] [0, 1, 0, 0, 1, 0, 1]	flat triad/mask bits [1, 5, 2, 7, 3, 4, 6] [1, 1, 0, 1, 1, 0, 1]	
60	$\frac{1}{r_m} \times \frac{1/3}{r_m}$		{D8, E7, D7, D6, H4a, dualSnub24, 24cellER8, 16cellER8, 24cellH4a, 16cellH4a}	0ppgssc 01010100 ₂	Bnf E8f Phi	0 1 0	1 -1 0	1 0 0	1 0 0	0 0 0	1 0 0	0 0 0	1 -1 -1	0 0 -1	0 0 0	Rf Wf Ht	0 -1 4	-1 -1 0	-1 0 0	-1 -1 0	-1 -1	28	Flipped Triad spin: 19 D ₈ R ₈ fp ₂ sm3-50H (1, 2, 6), (1, 3, 4), (1, 7, 5), (2, 3, 5), (2, 7, 4), (3, 7, 6), (4, 5, 6) [2, 4, 3], (2, 7, 4), (3, 5, 4), (4, 7)	Not Flipped Triad spin: 17 D ₈ R ₈ fp ₂ sm3-50H (1, 5, 2), (1, 3, 7), (1, 6, 4), (2, 3, 5), (2, 7, 4), (3, 7, 6), (4, 5, 6) [2, 4, 3], (2, 7, 4), (3, 5, 4), (4, 7)	flat triad/mask bits [1, 6, 2, 3, 4, 5, 7] [0, 0, 0, 0, 1, 0, 1]	flat triad/mask bits [1, 5, 2, 7, 3, 4, 6] [1, 0, 0, 1, 1, 0, 1]	
61	$\frac{r_{D6}}{r_m} \times \frac{0}{r_m}$		{D8, E7, D7, E6, D6, D5, H4, snub24, abSub24, snub24ER, snub24H4}	0ppgssc 00110110 ₂	Bnf E8f Phi	0 1 0	1 -1 0	1 0 0	1 0 0	0 0 0	1 0 0	0 0 0	1 0 0	0 0 0	0 0 0	Rf Wf Ht	0 -1 3	-1 -1 0	-1 0 0	-1 0 0	-1 0	21	Flipped Triad spin: 15 D ₈ R ₈ fp ₂ sm3-36H (1, 2, 5), (1, 6, 3), (1, 7, 4), (2, 3, 4), (2, 7, 4), (3, 7, 5), (4, 5, 6) [2, 3, 7], (2, 6, 4), (3, 5, 4), (5, 6)	Not Flipped Triad spin: 16 D ₈ R ₈ fp ₂ sm3-36H (1, 5, 2), (1, 4, 5), (1, 7, 4), (2, 6, 4), (3, 5, 4), (5, 6)	flat triad/mask bits [1, 5, 2, 6, 3, 7, 4] [0, 1, 1, 0, 1, 1, 0]	flat triad/mask bits [1, 2, 5, 6, 3, 7, 4] [0, 1, 1, 0, 1, 1, 0]	
62	$\frac{c}{2/3} \times \frac{0}{r_1}$		{D8, E7, D7, E6, D6, E5, D5, D4, F4s, H4, snub24, abSub24, snub24ER, snub24H4}	0ppgssc 01100101 ₂	Bnf E8f Phi	0 1 0	1 -1 0	1 0 0	1 0 0	0 0 0	0 0 0	0 0 0	1 1 1	0 0 0	0 0 0	Rf Wf Ht	0 -1 2	-1 -1 0	-1 0 0	-1 0 0	-1 0	14	Flipped Triad spin: 1 D ₈ R ₈ fp ₂ sm8-6DH (1, 2, 5), (1, 5, 4), (1, 7, 6), (2, 6, 4), (2, 5, 7), (3, 7, 4), (3, 6, 5) [2, 7, 3], (2, 5, 6), (3, 6, 4), (3, 7)	Not Flipped Triad spin: 2 D ₈ R ₈ fp ₂ sm8-6DH (1, 5, 2), (1, 4, 5), (1, 7, 4), (2, 6, 4), (2, 5, 7), (3, 7, 4), (3, 6, 5) [2, 7, 3], (2, 5, 6), (3, 6, 4), (3, 7)	flat triad/mask bits [1, 3, 2, 5, 4, 7, 6] [0, 1, 1, 1, 0, 1, 1]	flat triad/mask bits [1, 2, 4, 5, 7, 6] [1, 0, 1, 1, 0, 1, 1]	
63	$\frac{c}{2/3} \times \frac{0}{r_m}$		{D8, E7, D7, E6, D6, E5, D5, E4, D4, F4s, H4, snub24, abSub24, snub24ER, snub24H4, D3, D3}	0ppgssc 01100101 ₂	Bnf E8f Phi	0 1 0	1 -1 0	1 0 0	1 0 0	0 0 0	0 0 0	0 0 0	1 1 1	0 0 0	0 0 0	Rf Wf Ht	0 -1 1	-1 -2 1	0 0 0	0 0 0	0 0 0	7	Flipped Triad spin: 3 D ₈ R ₈ fp ₂ sm4-56H (1, 2, 5), (1, 6, 4), (1, 7, 5), (2, 4, 5), (2, 7, 4), (3, 7, 6), (4, 5, 6) [2, 7, 3], (2, 7, 4), (3, 4, 5), (3, 7)	Not Flipped Triad spin: 5 D ₈ R ₈ fp ₂ sm7-5FH (1, 5, 2), (1, 4, 5), (1, 7, 4), (2, 4, 5), (2, 7, 4), (3, 7, 6), (4, 5, 6) [2, 7, 3], (2, 7, 4), (3, 4, 5), (3, 7)	flat triad/mask bits [1, 3, 2, 6, 4, 7, 5] [0, 1, 1, 0, 1, 0, 1]	flat triad/mask bits [1, 2, 7, 4, 6, 5] [1, 1, 1, 1, 0, 1, 1]	
64	$\frac{c}{2/3} \times \frac{0}{r_m}$		{D8, E7, D7, E6, D6, E5, D5, D4, F4s, H4a, snub24H4a}	0ppgssc 01100101 ₂	Bnf E8f Phi	0 1 0	1 -1 0	1 0 0	1 0 0	1 0 0	1 0 0	0 0 0	1 0 0	0 0 0	0 0 0	Rf Wf Ht	0 1 7	0 1 0	-2 -1 0	-2 -1 0	-2 -1	46	Flipped Triad spin: 1 D ₈ R ₈ fp ₂ sm5-63H (1, 2, 5), (1, 5, 4), (1, 6, 7), (2, 4, 6), (2, 5, 7), (3, 4, 7), (3, 6, 5) [2, 4, 3], (2, 5, 6), (3, 4, 6), (3, 7)	Not Flipped Triad spin: 2 D ₈ R ₈ fp ₂ sm5-63H (1, 2, 5), (1, 6, 3), (1, 7, 5), (2, 4, 6), (2, 5, 7), (3, 4, 7), (3, 6, 5) [2, 4, 3], (2, 5, 6), (3, 4, 6), (3, 7)	flat triad/mask bits [1, 2, 3, 5, 4, 6, 7] [1, 1, 0, 0, 0, 0, 1]	flat triad/mask bits [1, 2, 3, 4, 5, 6, 7] [0, 0, 0, 0, 0, 0, 1]	
65	$\frac{\sqrt{2}}{2} \times \frac{1}{2}$		{D8, E7, D7, E6, D6, D5, H4, snub24, abSub24, snub24ER, snub24H4}	0ppgssc 01010100 ₂	Bnf E8f Phi	0 1 0	0 -1 0	1 0 0	1 -1 0	1 0 0	1 0 0	0 0 0	1 -1 -1	0 0 0	0 0 0	Rf Wf Ht	0 1 6	0 1 0	-1 1 0	-1 -1 0	-1 -1	38	Flipped Triad spin: 15 D ₈ R ₈ fp ₂ sm3-63H (1, 5, 2), (1, 6, 3), (1, 7, 4), (2, 3, 4), (2, 7, 4), (3, 7, 5), (4, 5, 6) [2, 3, 7], (2, 4, 6), (3, 5, 4), (5, 7)	Not Flipped Triad spin: 16 D ₈ R ₈ fp ₂ sm3-63H (1, 5, 2), (1, 6, 3), (1, 7, 4), (2, 3, 4), (2, 7, 4), (3, 7, 5), (4, 5, 6) [2, 3, 7], (2, 4, 6), (3, 5, 4), (5, 7)	flat triad/mask bits [1, 2, 5, 6, 3, 4, 7] [1, 1, 0, 0, 0, 1, 1]	flat triad/mask bits [1, 5, 2, 6, 3, 4, 7] [1, 1, 0, 0, 0, 1, 1]	
66	$\frac{c}{2/3} \times \frac{2/3}{r_d}$		{D8, E7, D7, D6, H4, snub24, abSub24, snub24ER, snub24H4}	0ppgssc 00110000 ₂	Bnf E8f Phi	0 1 0	0 -1 0	1 0 0	0 -1 0	0 0 0	1 1 1	1 1 1	0 0 0	0 0 0	0 0 0	Rf Wf Ht	0 1 5	0 1 0	-1 -1 0	-1 -1 -1	-1 -1	32	Flipped Triad spin: 19 D ₈ R ₈ fp ₂ sm3-05H (1, 6, 2), (1, 3, 4), (1, 7, 5), (2, 3, 5), (2, 7, 4), (3, 7, 6), (4, 5, 6) [2, 4, 3], (2, 7, 4), (3, 6, 5), (4, 5)	Not Flipped Triad spin: 17 D ₈ R ₈ fp ₂ sm3-05H (1, 5, 2), (1, 3, 7), (1, 6, 4), (2, 3, 5), (2, 7, 4), (3, 7, 6), (4, 5, 6) [2, 4, 3], (2, 7, 4), (3, 6, 5), (4, 5)	flat triad/mask bits [1, 2, 6, 3, 4, 7, 5] [1, 0, 1, 0, 0, 0, 0]	flat triad/mask bits [1, 2, 5, 7, 3, 6, 4] [0, 0, 1, 1, 0, 0, 0]	
67	$\frac{c}{2/3} \times \frac{2/3}{r_d}$		{D8, D7, H4, snub24, abSub24, snub24ER, 24cellH4, 16cellH4}	0ppgssc 00110001 ₂	Bnf E8f Phi	0 1 0	0 -1 0	1 0 0	0 0 0	0 -1 0	0 0 0	1 -1 1	0 -1 1	0 0 0	1 0 0	Rf Wf Ht	0 1 4	0 1 0	-1 -1 0	-1 -1 -1	-1 -1	27	Flipped Triad spin: 20 D ₈ R ₈ fp ₂ sm1-07H (1, 6, 2), (1, 4, 3), (1, 7, 5), (2, 3, 7), (2, 4, 5), (3, 5, 6), (4, 5, 6) [2, 6, 3], (2, 7, 4), (3, 4, 5), (5, 6)	Not Flipped Triad spin: 18 D ₈ R ₈ fp ₂ sm6-0EH (1, 5, 2), (1, 3, 7), (1, 6, 4), (2, 3, 7), (2, 4, 5), (3, 5, 6), (4, 5, 6) [2, 6, 3], (2, 7, 4), (3, 4, 5), (5, 6)	flat triad/mask bits [1, 2, 6, 4, 3, 7, 5] [1, 1, 1, 0, 0, 0, 0]	flat triad/mask bits [1, 2, 5, 7, 3, 6, 4] [0, 1, 1, 1, 0, 0, 0]	













68	$\frac{c}{b} \frac{2/3}{d} \frac{a}{L}$		{DS, H40, dualSub24, snub24H40}	Oppgssce 00100011 ₂	Bnl Ekl Phi	0 1 0 0 1 1 0 0 1 0 0 0 -1 0 0 0 0 -1 0 0 0 0 -1/√2 -1/√2 0 -1/√3 0 -√2/3	Flipped Triad spin=21 D _{6h} # fp _{sm6} =0EH [1, 2, 6], (1, 5, 3), (1, 7, 4), (2, 4, 3), (2, 5, 7), (3, 6, 7), (4, 5, 6) [2, 7, 3], (2, 4, 5), (3, 4, 6), (5, 6)	Not Flipped Triad spin=22 D _{6h} # fp _{sm6} =6EH [1, 2, 6], (1, 5, 3), (1, 7, 4), (2, 4, 3), (2, 5, 7), (3, 6, 7), (4, 5, 6) [2, 7, 3], (2, 4, 5), (3, 4, 6), (5, 6)	104
69	$\frac{1/3}{m} \frac{a}{R}$		{DS, H4, snub24, altSub24, snub24E8, snub24H4}	Oppgssce 01010011 ₂	Bnl Ekl Phi	0 1 0 0 1 0 0 1 0 0 0 0 -1 0 0 0 0 0 0 0 0 0 -1/√2 -1/√2 0 1/√3 0 √2/3	Flipped Triad spin=21 D _{6h} # fp _{sm6} =68H [1, 2, 6], (1, 3, 5), (1, 4, 7), (2, 4, 3), (2, 5, 7), (3, 7, 6), (4, 5, 6) [2, 7, 3], (2, 4, 5), (3, 6, 4), (5, 7)	Not Flipped Triad spin=22 D _{6h} # fp _{sm6} =68H [1, 2, 6], (1, 3, 5), (1, 4, 7), (2, 4, 3), (2, 5, 7), (3, 7, 6), (4, 5, 6) [2, 7, 3], (2, 4, 5), (3, 6, 4), (5, 7)	118
70	$\frac{1/3}{s} \frac{a}{R}$		{DS, D7, H40, dualSub24, 24cH40, 16cH40}	Oppgssce 01010010 ₂	Bnl Ekl Phi	0 1 0 0 1 0 0 1 0 0 0 0 -1 0 0 0 1 1 0 0 0 0 -1/√2 -1/√2 0 1/√3 1/√2 -1/√6	Flipped Triad spin=20 D _{6h} # fp _{sm6} =61H [1, 2, 6], (1, 3, 4), (1, 5, 7), (2, 3, 7), (2, 4, 5), (3, 6, 5), (4, 7, 6) [2, 7, 3], (2, 4, 5), (3, 5, 4), (5, 7)	Not Flipped Triad spin=18 D _{6h} # fp _{sm6} =68H [1, 2, 6], (1, 3, 5), (1, 4, 7), (2, 4, 3), (2, 5, 7), (3, 6, 5), (4, 5, 6) [2, 7, 3], (2, 4, 5), (3, 6, 4), (5, 7)	26
71	$\frac{1/3}{s} \frac{a}{R}$		{DS, E7, D7, D6, H40, dualSub24, snub24H40}	Oppgssce 01010010 ₂	Bnl Ekl Phi	0 1 0 0 1 0 0 1 0 0 0 0 -1 0 0 0 1 1 0 0 0 0 -1/√2 -1/√2 0 1/√3 -1/√2 -1/√6	Flipped Triad spin=19 D _{6h} # fp _{sm6} =63H [1, 2, 6], (1, 4, 3), (1, 5, 7), (2, 3, 5), (2, 4, 7), (3, 7, 6), (4, 5, 6) [2, 7, 3], (2, 4, 5), (3, 6, 5), (4, 7)	Not Flipped Triad spin=17 D _{6h} # fp _{sm6} =64H [1, 2, 6], (1, 3, 5), (1, 4, 7), (2, 4, 3), (2, 5, 7), (3, 6, 5), (4, 5, 6) [2, 7, 3], (2, 4, 5), (3, 6, 4), (5, 7)	20
72	$\frac{r}{w} \frac{0}{d} \frac{a}{L}$		{DS, E7, D7, E6, D6, D5, D5, H4, snub24, altSub24, snub24E8, snub24H4}	Oppgssce 00100000 ₂	Bnl Ekl Phi	0 1 0 0 1 0 0 0 0 0 0 0 -1 0 1 0 0 0 0 0 0 0 -1/√2 -1/√2 1 0 0 0	Flipped Triad spin=15 D _{6h} # fp _{sm6} =05H [1, 2, 6], (1, 3, 6), (1, 7, 4), (2, 3, 4), (2, 6, 7), (3, 5, 7), (4, 5, 6) [2, 7, 3], (2, 4, 6), (3, 4, 5), (5, 6)	Not Flipped Triad spin=16 D _{6h} # fp _{sm6} =05H [1, 2, 6], (1, 3, 6), (1, 7, 4), (2, 3, 4), (2, 6, 7), (3, 5, 7), (4, 5, 6) [2, 7, 3], (2, 4, 6), (3, 4, 5), (5, 6)	13
73	$\frac{b}{m} \frac{0}{L}$		{DS, E7, D7, E6, D6, E5, D5, D4, F4, H4, snub24, altSub24, snub24E8, snub24H4}	Oppgssce 00100101 ₂	Bnl Ekl Phi	0 1 0 0 0 0 0 1 1 0 0 0 -1 1 0 0 0 0 0 0 0 0 -√2 0 0 0 0	Flipped Triad spin=9 D _{6h} # fp _{sm6} =23H [1, 2, 6], (1, 6, 3), (1, 5, 7), (2, 3, 5), (2, 6, 7), (3, 7, 4), (4, 5, 6) [2, 7, 3], (2, 5, 7), (3, 5, 4), (3, 6)	Not Flipped Triad spin=6 D _{6h} # fp _{sm6} =23H [1, 2, 6], (1, 3, 6), (1, 7, 4), (2, 3, 4), (2, 6, 7), (3, 5, 7), (4, 5, 6) [2, 7, 3], (2, 4, 6), (3, 4, 5), (5, 6)	6
74	$\frac{c}{y} \frac{1/3}{d} \frac{a}{L}$		{DS, E7, D7, E6, D6, D5, D5, H4, snub24, altSub24, 16cH40, 16cH40}	Oppgssce 01010000 ₂	Bnl Ekl Phi	0 0 0 1 1 1 0 0 0 0 0 0 -1 -1 0 0 0 0 0 0 0 1/√2 -1/√2 -1 0 0 0	Flipped Triad spin=15 D _{6h} # fp _{sm6} =70H [1, 2, 6], (1, 3, 6), (1, 7, 4), (2, 4, 3), (2, 7, 6), (3, 7, 5), (4, 5, 6) [2, 7, 3], (2, 6, 4), (3, 5, 4), (5, 7)	Not Flipped Triad spin=16 D _{6h} # fp _{sm6} =70H [1, 2, 6], (1, 3, 6), (1, 7, 4), (2, 4, 3), (2, 7, 6), (3, 7, 5), (4, 5, 6) [2, 7, 3], (2, 6, 4), (3, 5, 4), (5, 7)	30
75	$\frac{c}{s} \frac{2/3}{d} \frac{a}{R}$		{DS, E7, D7, D6, H40, dualSub24, snub24H40}	Oppgssce 00100101 ₂	Bnl Ekl Phi	0 0 0 1 1 0 1 0 0 0 0 0 -1 -1 0 -1 0 0 0 0 0 1/√2 -1/√2 0 -1/√3 1/√2 1/√6	Flipped Triad spin=19 D _{6h} # fp _{sm6} =10H [1, 2, 6], (1, 4, 3), (1, 5, 7), (2, 3, 5), (2, 7, 4), (3, 6, 7), (4, 5, 6) [2, 7, 3], (2, 4, 6), (3, 5, 4), (4, 5)	Not Flipped Triad spin=17 D _{6h} # fp _{sm6} =12H [1, 2, 6], (1, 3, 5), (1, 4, 7), (2, 4, 3), (2, 5, 7), (3, 6, 5), (4, 5, 6) [2, 7, 3], (2, 4, 5), (3, 6, 4), (5, 7)	24
76	$\frac{c}{s} \frac{2/3}{d} \frac{a}{R}$		{DS, D7, H4, snub24, altSub24, 16cH40, 16cH40}	Oppgssce 00100101 ₂	Bnl Ekl Phi	0 0 0 1 1 0 0 1 0 0 0 0 -1 -1 0 0 -1 0 0 0 0 1/√2 -1/√2 0 -1/√3 -1/√2 1/√6	Flipped Triad spin=20 D _{6h} # fp _{sm6} =19H [1, 2, 6], (1, 3, 4), (1, 5, 7), (2, 7, 3), (2, 5, 4), (3, 5, 6), (4, 6, 7) [2, 7, 3], (2, 7, 4), (3, 4, 5), (5, 6)	Not Flipped Triad spin=18 D _{6h} # fp _{sm6} =10H [1, 2, 6], (1, 3, 5), (1, 4, 7), (2, 4, 3), (2, 5, 7), (3, 6, 5), (4, 5, 6) [2, 7, 3], (2, 4, 6), (3, 4, 5), (5, 6)	19
77	$\frac{c}{b} \frac{2/3}{d} \frac{a}{L}$		{DS, H4, snub24, altSub24, 16cH40, 24cH40, 16cH40}	Oppgssce 00100111 ₂	Bnl Ekl Phi	0 0 0 1 1 0 0 0 1 0 0 0 0 -1 0 0 0 -1 0 0 0 0 1/√2 -1/√2 0 -1/√3 0 -√2/3	Flipped Triad spin=21 D _{6h} # fp _{sm6} =10H [1, 2, 6], (1, 3, 5), (1, 4, 7), (2, 3, 4), (2, 7, 5), (3, 6, 7), (4, 5, 6) [2, 7, 3], (2, 5, 4), (3, 4, 6), (5, 6)	Not Flipped Triad spin=22 D _{6h} # fp _{sm6} =10H [1, 2, 6], (1, 3, 5), (1, 4, 7), (2, 3, 4), (2, 7, 5), (3, 6, 7), (4, 5, 6) [2, 7, 3], (2, 5, 4), (3, 4, 6), (5, 6)	107
78	$\frac{1/3}{m} \frac{a}{R}$		{DS, H40, dualSub24, 24cH40, 16cH40}	Oppgssce 01010001 ₂	Bnl Ekl Phi	0 0 0 1 0 1 1 0 0 0 0 0 0 -1 0 0 0 1 0 0 0 0 1/√2 -1/√2 0 1/√3 0 √2/3	Flipped Triad spin=21 D _{6h} # fp _{sm6} =76H [1, 2, 6], (1, 3, 5), (1, 7, 4), (2, 3, 4), (2, 7, 5), (3, 7, 6), (4, 5, 6) [2, 7, 3], (2, 5, 4), (3, 6, 4), (5, 7)	Not Flipped Triad spin=22 D _{6h} # fp _{sm6} =76H [1, 2, 6], (1, 3, 5), (1, 7, 4), (2, 3, 4), (2, 7, 5), (3, 7, 6), (4, 5, 6) [2, 7, 3], (2, 5, 4), (3, 6, 4), (5, 7)	117
79	$\frac{1/3}{s} \frac{a}{L}$		{DS, D7, H40, dualSub24, snub24H40}	Oppgssce 01010010 ₂	Bnl Ekl Phi	0 0 0 1 0 1 0 0 1 0 0 0 0 -1 0 0 1 0 0 0 0 0 1/√2 -1/√2 0 1/√3 1/√2 -1/√6	Flipped Triad spin=20 D _{6h} # fp _{sm6} =76H [1, 2, 6], (1, 4, 3), (1, 7, 5), (2, 7, 3), (2, 5, 4), (3, 6, 5), (4, 7, 6) [2, 7, 3], (2, 4, 5), (3, 5, 4), (5, 7)	Not Flipped Triad spin=18 D _{6h} # fp _{sm6} =76H [1, 2, 6], (1, 3, 5), (1, 4, 7), (2, 7, 3), (2, 5, 4), (3, 6, 4), (5, 7)	18
80	$\frac{1/3}{s} \frac{a}{L}$		{DS, E7, D7, D6, H4, snub24, altSub24, snub24E8, snub24H4}	Oppgssce 01010000 ₂	Bnl Ekl Phi	0 0 0 1 0 1 0 0 1 0 0 0 0 -1 0 1 0 0 0 0 0 0 1/√2 -1/√2 0 1/√3 -1/√2 -1/√6	Flipped Triad spin=19 D _{6h} # fp _{sm6} =70H [1, 2, 6], (1, 3, 6), (1, 7, 5), (2, 3, 5), (2, 7, 4), (3, 7, 6), (4, 5, 6) [2, 7, 3], (2, 4, 6), (3, 6, 5), (4, 7)	Not Flipped Triad spin=17 D _{6h} # fp _{sm6} =74H [1, 2, 6], (1, 3, 4), (1, 7, 5), (2, 5, 2), (1, 6, 3), (1, 4, 7), (2, 4, 3), (2, 7, 6), (3, 7, 5), (4, 5, 6) [2, 7, 3], (2, 6, 4), (3, 4, 5), (4, 7)	12
81	$\frac{r}{w} \frac{0}{d} \frac{a}{L}$		{DS, E7, D7, E6, D6, D5, H4, snub24, altSub24, snub24E8, snub24H4}	Oppgssce 00100100 ₂	Bnl Ekl Phi	0 0 0 1 0 0 1 0 0 0 0 0 0 -1 1 0 0 0 0 0 0 0 1/√2 -1/√2 1 0 0 0	Flipped Triad spin=15 D _{6h} # fp _{sm6} =10H [1, 2, 6], (1, 3, 6), (1, 7, 4), (2, 3, 4), (2, 7, 6), (3, 7, 5), (4, 5, 6) [2, 7, 3], (2, 4, 6), (3, 4, 5), (5, 6)	Not Flipped Triad spin=16 D _{6h} # fp _{sm6} =10H [1, 2, 6], (1, 3, 6), (1, 7, 4), (2, 3, 4), (2, 7, 6), (3, 7, 5), (4, 5, 6) [2, 7, 3], (2, 4, 6), (3, 4, 5), (5, 6)	5

82			[DK, E7, D7, D6, D4, F4, H4, snub24, snub24ER, snub24H4] Φ_{10} 010001001 ₂	0ppgssce 010001011 ₂	Bnl ERl Phl	0 0 0	0 0 0	1 0 0	0 0 0	0 -1 -1	1 1 -1	0 0 0	Rt Wt Ht	0 0 3	0 0 1	-1 1 -1	-1 -1 -1	5 16	Flipped Triad fp1=2 D ₆ H fp_snm8=59H (1, 2, 3), (1, 4, 5), (1, 6, 7), (2, 7, 4), (2, 6, 5), (3, 4, 6), (3, 7, 5), [2, 6, 4], (2, 7, 5), (3, 4, 7), (3, 6)	Not Flipped Triad fp1=2 D ₆ H fp_snm5=5AH (1, 2, 3), (1, 4, 5), (1, 6, 7), (2, 7, 4), (2, 6, 5), (3, 4, 6), (3, 7, 5), [2, 6, 4], (2, 7, 5), (3, 4, 7), (3, 6)	flat triad/mask bits [1, 2, 3, 4, 5, 6, 7] [0, 1, 0, 1, 1, 0, 1]	flat triad/mask bits [1, 2, 3, 4, 5, 6, 7] [0, 1, 0, 1, 1, 0, 1]	
83			[DK, D7, D4, F4, H4, snub24, snub24ER, snub24H4] Φ_{10} 010001010 ₂	0ppgssce 010001010 ₂	Bnl ERl Phl	0 0 0	0 0 0	1 0 0	0 -1 -1	0 1 1	0 1 1	0 1 1	Rt Wt Ht	0 0 2	0 0 1	-1 -1 1	0 1 1	0 1 1	Ne 10	Flipped Triad fp1=5 D ₆ H fp_snm7=58H (1, 2, 3), (1, 4, 7), (1, 5, 6), (2, 5, 4), (2, 7, 6), (3, 4, 6), (3, 7, 5), [2, 6, 4], (2, 7, 5), (3, 4, 7), (3, 6)	Not Flipped Triad fp1=3 D ₆ H fp_snm4=51H (1, 2, 3), (1, 4, 6), (1, 5, 7), (2, 5, 4), (2, 7, 6), (3, 4, 6), (3, 7, 5), [2, 6, 4], (2, 7, 5), (3, 4, 7), (3, 6)	flat triad/mask bits [1, 3, 2, 4, 7, 5, 6] [0, 0, 0, 1, 1, 0, 1]	flat triad/mask bits [1, 3, 2, 4, 6, 5, 7] [1, 0, 0, 1, 1, 0, 1]
84			[DK, D4, F4, H4, snub24, snub24ER, snub24H4] Φ_{10} 010001011 ₂	0ppgssce 010001011 ₂	Bnl ERl Phl	0 0 0	0 0 0	1 1 -1	1 0 0	1 0 -1	1 0 -1	0 0 -1	Rt Wt Ht	1 0 21	2 0 1	3 1 0	4 2 -1	2 3 0	Ds 110	Flipped Triad fp1=9 D ₆ H fp_snm6=5BH (1, 4, 2), (1, 6, 3), (1, 5, 7), (2, 5, 3), (2, 7, 6), (3, 4, 7), (4, 6, 5), [2, 6, 4], (2, 7, 5), (3, 4, 5), (3, 4, 7), (3, 6)	Not Flipped Triad fp1=6 D ₆ H fp_snm6=5BH (1, 2, 3), (1, 4, 7), (1, 5, 6), (2, 5, 4), (2, 7, 6), (3, 4, 6), (3, 7, 5), [2, 6, 4], (2, 7, 5), (3, 4, 7), (3, 6)	flat triad/mask bits [1, 2, 4, 6, 3, 5, 7] [1, 1, 0, 1, 1, 0, 1]	flat triad/mask bits [1, 3, 2, 7, 4, 5, 6] [1, 1, 0, 1, 1, 0, 1]
85			[DK, D4, F4, H4, snub24, snub24ER, snub24H4] Φ_{10} 000000011 ₂	0ppgssce 000000011 ₂	Bnl ERl Phl	0 0 0	0 0 0	1 1 -1	1 0 0	1 0 0	0 1 0	0 1 0	Rt Wt Ht	-1 0 25	-2 0 1	-3 1 0	-4 -2 0	-4 -6 -3	Lv 116	Flipped Triad fp1=6 D ₆ H fp_snm6=09H (1, 2, 3), (1, 4, 7), (1, 5, 6), (2, 6, 4), (2, 7, 5), (3, 4, 5), (3, 6, 7), [2, 6, 4], (2, 7, 5), (3, 4, 7), (4, 5)	Not Flipped Triad fp1=9 D ₆ H fp_snm6=09H (1, 2, 3), (1, 4, 7), (1, 5, 6), (2, 6, 4), (2, 7, 5), (3, 4, 5), (3, 6, 7), [2, 6, 4], (2, 7, 5), (3, 4, 7), (4, 5)	flat triad/mask bits [1, 2, 3, 4, 7, 5, 6] [1, 0, 0, 1, 0, 0, 0]	flat triad/mask bits [1, 4, 2, 6, 5, 7] [1, 0, 0, 1, 0, 0, 0]
86			[DK, D7, D4, F4, H4, snub24, snub24ER, snub24H4] Φ_{10} 000000101 ₂	0ppgssce 000000101 ₂	Bnl ERl Phl	0 0 0	0 0 0	1 1 -1	1 0 0	1 0 -1	0 0 1	0 0 1	Rt Wt Ht	0 0 2	0 0 1	0 0 1	-1 -1 -1	-1 -1 -1	F 9	Flipped Triad fp1=3 D ₆ H fp_snm4=03H (1, 2, 3), (1, 6, 4), (1, 5, 6), (2, 4, 5), (2, 7, 6), (3, 4, 7), (3, 5, 6), [2, 6, 4], (2, 7, 5), (3, 4, 6), (3, 5)	Not Flipped Triad fp1=5 D ₆ H fp_snm7=0AH (1, 2, 3), (1, 4, 7), (1, 5, 6), (2, 4, 5), (2, 7, 6), (3, 4, 7), (3, 5, 6), [2, 6, 4], (2, 7, 5), (3, 4, 6), (3, 5)	flat triad/mask bits [1, 2, 3, 6, 4, 5, 7] [1, 1, 0, 0, 0, 0, 0]	flat triad/mask bits [1, 2, 3, 7, 4, 5, 6] [0, 1, 0, 1, 0, 0, 0]
87			[DK, E7, D7, D6, D4, F4, H4, snub24, snub24ER, snub24H4] Φ_{10} 000000001 ₂	0ppgssce 000000001 ₂	Bnl ERl Phl	0 0 0	0 0 0	1 1 -1	1 1 -1	0 0 -1	1 1 -1	0 0 -1	Rt Wt Ht	0 0 1	0 0 1	0 0 -1	0 -1 -1	0 -1 -1	He 2	Flipped Triad fp1=8 D ₆ H fp_snm4=08H (1, 2, 3), (1, 4, 5), (1, 6, 7), (2, 6, 4), (2, 7, 5), (3, 4, 7), (3, 5, 6), [2, 6, 4], (2, 7, 5), (3, 4, 6), (3, 5)	Not Flipped Triad fp1=2 D ₆ H fp_snm8=08H (1, 2, 3), (1, 4, 7), (1, 5, 6), (2, 6, 4), (2, 7, 5), (3, 4, 7), (3, 5, 6), [2, 6, 4], (2, 7, 5), (3, 4, 6), (3, 5)	flat triad/mask bits [1, 3, 2, 4, 5, 6, 7] [0, 0, 0, 1, 0, 0, 0]	flat triad/mask bits [1, 3, 2, 5, 4, 6, 7] [1, 1, 0, 1, 0, 0, 0]
88			[DK, D7, D4, F4, H4, snub24, snub24ER, snub24H4] Φ_{10} 000000111 ₂	0ppgssce 000000111 ₂	Bnl ERl Phl	0 0 0	0 0 0	1 0 -2	1 -1 0	0 -1 0	0 1 0	0 1 0	Rt Wt Ht	0 0 1	0 0 1	0 -1 -2	0 0 1	0 0 1	Li 3	Flipped Triad fp1=6 D ₆ H fp_snm6=17H (1, 2, 3), (1, 7, 4), (1, 6, 5), (2, 4, 6), (2, 7, 5), (3, 4, 5), (3, 6, 7), [2, 6, 4], (2, 7, 5), (3, 4, 7), (4, 5)	Not Flipped Triad fp1=9 D ₆ H fp_snm6=17H (1, 2, 3), (1, 4, 7), (1, 5, 6), (2, 4, 5), (2, 7, 6), (3, 4, 7), (3, 5, 6), [2, 6, 4], (2, 7, 5), (3, 4, 6), (3, 5)	flat triad/mask bits [1, 2, 3, 7, 4, 6, 5] [1, 1, 1, 0, 1, 0, 0]	flat triad/mask bits [1, 4, 2, 6, 3, 7, 5] [1, 1, 1, 0, 1, 0, 0]
89			[DK, D4, F4, H4, snub24, snub24ER, snub24H4] Φ_{10} 000000110 ₂	0ppgssce 000000110 ₂	Bnl ERl Phl	0 0 0	0 0 0	1 0 -2	1 0 -1	0 1 -1	1 1 -1	0 1 -1	Rt Wt Ht	1 0 22	2 0 0	3 4 1	2 3 -1	5 2 -1	Cn 112	Flipped Triad fp1=3 D ₆ H fp_snm4=10H (1, 2, 3), (1, 4, 6), (1, 5, 7), (2, 5, 4), (2, 7, 6), (3, 4, 7), (3, 5, 6), [2, 6, 4], (2, 7, 5), (3, 4, 6), (3, 5)	Not Flipped Triad fp1=5 D ₆ H fp_snm7=14H (1, 2, 3), (1, 4, 7), (1, 5, 6), (2, 4, 5), (2, 7, 6), (3, 4, 7), (3, 5, 6), [2, 6, 4], (2, 7, 5), (3, 4, 6), (3, 5)	flat triad/mask bits [1, 2, 3, 4, 6, 7, 5] [1, 0, 1, 1, 1, 0, 0]	flat triad/mask bits [1, 2, 3, 4, 7, 6, 5] [0, 1, 0, 1, 1, 0, 0]
90			[DK, D4, F4, H4, snub24, snub24ER, snub24H4, G2] Φ_{10} 000001111 ₂	0ppgssce 000001111 ₂	Bnl ERl Phl	0 0 0	0 0 0	1 0 0	1 -1 0	1 0 0	1 0 0	1 0 0	Rt Wt Ht	-1 0 24	-2 0 0	-3 0 0	-4 -2 -1	-4 -5 -3	Uup 115	Flipped Triad fp1=6 D ₆ H fp_snm6=2AH (1, 2, 3), (1, 7, 4), (1, 5, 6), (2, 6, 4), (2, 7, 5), (3, 4, 5), (3, 6, 7), [2, 6, 4], (2, 7, 5), (3, 4, 7), (4, 5)	Not Flipped Triad fp1=9 D ₆ H fp_snm6=2AH (1, 2, 3), (1, 4, 7), (1, 5, 6), (2, 4, 5), (2, 7, 6), (3, 4, 7), (3, 5, 6), [2, 6, 4], (2, 7, 5), (3, 4, 6), (3, 5)	flat triad/mask bits [1, 3, 2, 7, 4, 5, 6] [0, 1, 0, 1, 1, 1, 0]	flat triad/mask bits [1, 2, 4, 6, 3, 5, 7] [0, 1, 0, 1, 1, 1, 0]
91			[DK, D7, D4, F4, H4, snub24, snub24ER, snub24H4, G2] Φ_{10} 000001110 ₂	0ppgssce 000001110 ₂	Bnl ERl Phl	0 0 0	0 0 0	1 0 0	1 -1 0	1 0 0	1 0 0	1 0 0	Rt Wt Ht	0 0 1	0 0 0	0 0 0	0 -1 -2	0 1 -2	H 11	Flipped Triad fp1=3 D ₆ H fp_snm4=30H (1, 2, 3), (1, 4, 6), (1, 5, 7), (2, 4, 5), (2, 7, 6), (3, 4, 7), (3, 5, 6), [2, 6, 4], (2, 7, 5), (3, 4, 6), (3, 5)	Not Flipped Triad fp1=5 D ₆ H fp_snm7=39H (1, 2, 3), (1, 4, 7), (1, 5, 6), (2, 4, 5), (2, 7, 6), (3, 4, 7), (3, 5, 6), [2, 6, 4], (2, 7, 5), (3, 4, 6), (3, 5)	flat triad/mask bits [1, 3, 2, 4, 6, 5, 7] [0, 0, 0, 1, 1, 1, 0]	flat triad/mask bits [1, 3, 2, 4, 7, 5, 6] [1, 0, 0, 1, 1, 1, 0]
92			[DK, E7, D7, D6, D4, F4, H4, snub24, snub24ER, snub24H4] Φ_{10} 000001011 ₂	0ppgssce 000001011 ₂	Bnl ERl Phl	0 0 0	0 0 0	1 0 -2	1 0 -1	0 -1 -1	1 -1 -1	0 -1 -1	Rt Wt Ht	1 0 23	2 0 0	3 0 1	4 2 -1	3 5 1	Uit 113	Flipped Triad fp1=8 D ₆ H fp_snm5=16H (1, 2, 3), (1, 5, 4), (1, 7, 6), (2, 4, 6), (2, 7, 5), (3, 4, 7), (3, 5, 6), [2, 6, 4], (2, 7, 5), (3, 4, 6), (3, 5)	Not Flipped Triad fp1=2 D ₆ H fp_snm8=15H (1, 2, 3), (1, 4, 7), (1, 5, 6), (2, 4, 5), (2, 7, 6), (3, 4, 7), (3, 5, 6), [2, 6, 4], (2, 7, 5), (3, 4, 6), (3, 5)	flat triad/mask bits [1, 3, 2, 5, 4, 7, 6] [0, 1, 1, 0, 1, 0, 0]	flat triad/mask bits [1, 3, 2, 4, 5, 7, 6] [1, 0, 1, 0, 1, 0, 0]
93			[DK, D4, F4, H4, snub24, snub24ER, snub24H4, G2] Φ_{10} 000001101 ₂	0ppgssce 000001101 ₂	Bnl ERl Phl	0 0 0	0 0 0	1 0 -1	1 -1 0	1 0 0	1 -1 0	1 1 0	Rt Wt Ht	-1 0 23	-2 0 0	-3 0 0	-4 -2 -1	-4 -5 -2	F1 114	Flipped Triad fp1=1 D ₆ H fp_snm5=38H (1, 2, 3), (1, 5, 4), (1, 6, 7), (2, 6, 4), (2, 7, 5), (3, 7, 4), (3, 5, 6), [2, 6, 4], (2, 7, 5), (3, 6, 4), (3, 5)	Not Flipped Triad fp1=2 D ₆ H fp_snm8=38H (1, 2, 3), (1, 4, 7), (1, 5, 6), (2, 6, 4), (2, 7, 5), (3, 7, 4), (3, 5, 6), [2, 6, 4], (2, 7, 5), (3, 6, 4), (3, 5)	flat triad/mask bits [1, 2, 3, 5, 4, 6, 7] [1, 1, 0, 1, 1, 1, 0]	flat triad/mask bits [1, 2, 3, 4, 5, 6, 7] [0, 0, 0, 1, 1, 1, 0]

pascalRow5

Seq #	Symbol	2D/3D Shape	Groups	Particle Quantum Bits	Binary / ER / Physics Coordinates	Algebra Root Weight / Height / BZ=Atomic Element Number -->	Ek #	Octonions															
94			[BC8, E7, E6, 6Cube, E5, C4, H40, 24cell, 8Cell, dualSnub24, 24cellE80, 24cellH40, 3Cube, Hamming] Φ_{10} 000010000 ₂	0ppgssce 000010000 ₂	Bnl ERl Phl	1 1 2	1 1 2	1 1 2	1 1 2	0 -1 2	1 -1 2	0 -1 2	Rt Wt Ht	1 2 19	2 0 3	4 4 1	1 2 -2	4 2 0	Sq 166	Flipped Triad fp1=4 BC ₈ H fp_snm3=02H (1, 2, 3), (1, 6, 4), (1, 5, 7), (2, 4, 7), (2, 5, 6), (3, 4, 5), (3, 6, 7), [2, 6, 4], (2, 7, 5), (3, 4, 6), (3, 5)	Not Flipped Triad fp1=7 BC ₈ H fp_snm3=02H (1, 2, 3), (1, 4, 5), (1, 6, 7), (2, 4, 7), (2, 5, 6), (3, 4, 5), (3, 6, 7), [2, 6, 4], (2, 7, 5), (3, 4, 6), (3, 5)	flat triad/mask bits [1, 3, 2, 6, 4, 5, 7] [0, 1, 0, 0, 0, 0, 0]	flat triad/mask bits [1, 2, 4, 5, 3, 6, 7] [0, 1, 0, 0, 0, 0, 0]

123	$d \sim -1/3$ $c \sim m$ K		{BC8, I140, duaSub24, snub24I140}	Ogggsse 000011110 ₂	BaI E8I WdI PhI	1 0 0 1 0 1 0 1 0 1 1 1 1 1 1 1 1 1 2 2 2 2 2 2 2 2 2 1 1 1 1 1 1 1 1 1 2 2 0 2 2 2 2 2 2		Flipped Triad fpi11 BC ₈ H ₃ fp ₃ sm1=33H Not Flipped Triad fpi12 BC ₈ H ₃ fp ₃ sm5=30H	$(2, 4, 2), (1, 7, 3), (1, 5, 6), (1, 2, 4), (1, 3, 7), (1, 5, 4), (2, 3, 5), (2, 7, 6), (3, 6, 4), (4, 5, 7), (2, 3, 6), (2, 7, 5), (3, 5, 4), (4, 6, 7), (1, 2, 4, 3, 7, 5, 6), (1, 1, 0, 0, 1, 1, 0)$
124	$d \sim -1/3$ $c \sim m$ K		{BC8, E7, H4, snub24, abSub24, snub24E8, snub24I4}	Ogggsse 000011101 ₂	BaI E8I WdI PhI	1 0 0 1 0 0 1 0 0 1 1 1 1 1 1 1 1 1 2 2 2 2 2 2 2 2 2 1 1 1 1 1 1 1 1 1 2 2 0 2 2 2 2 2 2		Flipped Triad fpi8 BC ₈ H ₃ fp ₃ sm2=32H Not Flipped Triad fpi10 BC ₈ H ₃ fp ₃ sm5=30H	$(2, 2, 4), (1, 5, 3), (1, 6, 7), (1, 2, 7), (1, 3, 6), (1, 4, 5), (2, 3, 7), (2, 6, 5), (3, 6, 4), (4, 5, 7), (2, 3, 5), (2, 6, 4), (3, 5, 4), (4, 6, 7), (1, 2, 4, 3, 6, 5, 7), (1, 1, 0, 0, 1, 1, 0)$
125	$t \sim 2/3$ $b \sim 1$ R		{BC8, 6Cube, H140, duaSub24, 24ceH80, snub24I40}	Ogggsse 001110111 ₂	BaI E8I WdI PhI	1 0 0 0 1 1 1 1 0 1 1 1 1 1 1 1 1 1 2 2 2 2 2 2 2 2 2 1 1 1 1 1 1 1 1 1 2 2 0 2 2 2 2 2 2		Flipped Triad fpi28 BC ₈ H ₃ fp ₃ sm3=10H Not Flipped Triad fpi20 BC ₈ H ₃ fp ₃ sm6=10H	$(2, 7, 2), (1, 5, 3), (1, 4, 6), (1, 2, 7), (1, 3, 6), (1, 4, 5), (2, 6, 3), (2, 5, 4), (3, 4, 7), (4, 5, 7), (2, 3, 5), (2, 6, 4), (3, 4, 7), (5, 6, 7), (1, 2, 7, 3, 4, 6), (1, 1, 0, 0, 1, 1, 0)$
126	$t \sim 2/3$ $b \sim 1$ R		{BC8, H140, duaSub24, 24ceH80, snub24I40}	Ogggsse 001110101 ₂	BaI E8I WdI PhI	1 0 0 0 1 1 1 1 0 1 1 1 1 1 1 1 1 1 2 2 2 2 2 2 2 2 2 1 1 1 1 1 1 1 1 1 2 2 0 2 2 2 2 2 2		Flipped Triad fpi29 BC ₈ H ₃ fp ₃ sm7=13H Not Flipped Triad fpi27 BC ₈ H ₃ fp ₃ sm4=14H	$(2, 7, 2), (1, 6, 3), (1, 4, 5), (1, 2, 7), (1, 3, 6), (1, 4, 5), (2, 3, 4), (2, 6, 5), (3, 5, 7), (4, 6, 7), (2, 3, 5), (2, 6, 4), (3, 6, 7), (4, 5, 6, 7), (1, 2, 7, 3, 4, 6), (1, 1, 0, 0, 1, 1, 0)$
127	$t \sim 2/3$ $b \sim 1$ R		{BC8, E7, H140, duaSub24, 24ceH80, snub24I40, Idempot}	Ogggsse 001110101 ₂	BaI E8I WdI PhI	1 0 0 0 1 1 1 1 0 1 1 1 1 1 1 1 1 1 2 2 2 2 2 2 2 2 2 1 1 1 1 1 1 1 1 1 2 2 0 2 2 2 2 2 2		Flipped Triad fpi26 BC ₈ H ₃ fp ₃ sm8=12H Not Flipped Triad fpi25 BC ₈ H ₃ fp ₃ sm5=11H	$(2, 2, 6), (1, 3, 7), (1, 5, 6), (1, 2, 7), (1, 3, 4), (1, 5, 6), (2, 3, 4), (2, 5, 4), (3, 5, 7), (4, 6, 7), (2, 3, 5), (2, 6, 4), (3, 6, 7), (4, 5, 6, 7), (1, 2, 7, 3, 4, 6), (1, 0, 0, 0, 1, 1, 0)$
128	$r \sim 0$ $v \sim 1$ R		{BC8, E7, E6, H140, duaSub24, 24ceH80, 24ceH140}	Ogggsse 001110100 ₂	BaI E8I WdI PhI	1 0 0 0 1 1 1 1 0 1 1 1 1 1 1 1 1 1 2 2 2 2 2 2 2 2 2 1 1 1 1 1 1 1 1 1 2 2 0 2 2 2 2 2 2		Flipped Triad fpi23 BC ₈ H ₃ fp ₃ sm2=18H Not Flipped Triad fpi24 BC ₈ H ₃ fp ₃ sm3=18H	$(2, 2, 6), (1, 3, 7), (1, 4, 5), (1, 2, 7), (1, 3, 4), (1, 5, 6), (2, 4, 3), (2, 7, 5), (3, 5, 6), (4, 6, 7), (2, 3, 5), (2, 7, 4), (3, 4, 6), (5, 6, 7), (1, 2, 7, 3, 4, 5), (1, 1, 0, 0, 1, 1, 0)$
129	$r \sim 0$ $v \sim 1$ R		{BC8, E7, E6, 6Cube, C4, H140, 24ceL, 8cL, duaSub24, 24ceH80, 24ceH140}	Ogggsse 011110100 ₂	BaI E8I WdI PhI	0 1 1 1 1 1 1 0 0 1 1 1 1 1 1 1 1 1 2 2 2 2 2 2 2 2 2 1 1 1 1 1 1 1 1 1 2 2 0 2 2 2 2 2 2		Flipped Triad fpi24 BC ₈ H ₃ fp ₃ sm3=64H Not Flipped Triad fpi25 BC ₈ H ₃ fp ₃ sm2=67H	$(2, 2, 6), (1, 3, 7), (1, 4, 5), (1, 2, 7), (1, 3, 4), (1, 5, 6), (2, 3, 5), (2, 4, 7), (3, 6, 4), (5, 7, 6), (2, 3, 4), (2, 5, 7), (3, 6, 5), (4, 7, 8), (1, 2, 7, 3, 4, 5), (1, 1, 1, 0, 0, 1, 1)$
130	$t \sim -2/3$ $b \sim 1$ R		{BC8, E7, 6Cube, C4, H140, duaSub24, snub24I40, Idempot}	Ogggsse 011110101 ₂	BaI E8I WdI PhI	0 1 1 1 1 1 0 1 0 1 1 1 1 1 1 1 1 1 2 2 2 2 2 2 2 2 2 1 1 1 1 1 1 1 1 1 2 2 0 2 2 2 2 2 2		Flipped Triad fpi25 BC ₈ H ₃ fp ₃ sm5=63H Not Flipped Triad fpi26 BC ₈ H ₃ fp ₃ sm8=69H	$(2, 2, 7), (1, 4, 3), (1, 6, 5), (1, 2, 7), (1, 3, 4), (1, 5, 6), (2, 5, 3), (2, 4, 8), (3, 7, 6), (4, 7, 5), (2, 3, 6), (2, 4, 5), (3, 7, 5), (4, 7, 8), (1, 2, 7, 3, 4, 6, 5), (1, 0, 1, 1, 0, 1, 1)$
131	$t \sim -2/3$ $b \sim 1$ R		{BC8, 6Cube, H140, duaSub24, snub24I40}	Ogggsse 011110101 ₂	BaI E8I WdI PhI	0 1 1 1 1 1 0 1 0 1 1 1 1 1 1 1 1 1 2 2 2 2 2 2 2 2 2 1 1 1 1 1 1 1 1 1 2 2 0 2 2 2 2 2 2		Flipped Triad fpi27 BC ₈ H ₃ fp ₃ sm4=65H Not Flipped Triad fpi29 BC ₈ H ₃ fp ₃ sm7=63H	$(2, 7, 2), (1, 3, 5), (1, 6, 5), (1, 2, 7), (1, 3, 4), (1, 5, 6), (2, 3, 4), (2, 5, 4), (3, 7, 6), (4, 7, 5), (2, 3, 6), (2, 5, 6), (3, 7, 5), (4, 7, 8), (1, 2, 7, 3, 5, 6, 4), (1, 0, 1, 0, 0, 1, 1)$
132	$t \sim -2/3$ $b \sim 1$ R		{BC8, H140, duaSub24, snub24I40}	Ogggsse 011110111 ₂	BaI E8I WdI PhI	0 1 1 1 1 1 0 1 0 1 1 1 1 1 1 1 1 1 2 2 2 2 2 2 2 2 2 1 1 1 1 1 1 1 1 1 2 2 0 2 2 2 2 2 2		Flipped Triad fpi10 BC ₈ H ₃ fp ₃ sm5=44H Not Flipped Triad fpi8 BC ₈ H ₃ fp ₃ sm2=4DH	$(2, 2, 4), (1, 3, 6), (1, 7, 5), (1, 2, 7), (1, 3, 5), (1, 6, 4), (2, 5, 3), (2, 4, 8), (3, 7, 4), (5, 7, 6), (2, 4, 5), (3, 7, 4), (5, 7, 8), (1, 2, 7, 3, 5, 6, 4), (1, 1, 1, 0, 0, 1, 1)$
133	$d \sim 1/3$ $c \sim m$ R		{BC8, E7, 6Cube, C4, H4, snub24, abSub24, ceH8, snub24I4}	Ogggsse 010011101 ₂	BaI E8I WdI PhI	0 1 1 1 1 0 1 1 0 1 1 1 1 1 1 1 1 1 2 2 2 2 2 2 2 2 2 1 1 1 1 1 1 1 1 1 2 2 0 2 2 2 2 2 2		Flipped Triad fpi12 BC ₈ H ₃ fp ₃ sm4=4FH Not Flipped Triad fpi11 BC ₈ H ₃ fp ₃ sm1=4CH	$(2, 4, 2), (1, 7, 3), (1, 7, 5), (1, 2, 7), (1, 3, 7), (1, 6, 5), (2, 6, 3), (2, 5, 7), (3, 4, 5), (4, 7, 6), (2, 3, 5), (2, 5, 6), (3, 4, 6), (3, 4, 7), (4, 7, 8), (1, 2, 4, 3, 7, 6), (1, 1, 1, 0, 0, 1)$
134	$d \sim 1/3$ $c \sim m$ R		{BC8, 6Cube, H140, duaSub24, snub24I40}	Ogggsse 010011110 ₂	BaI E8I WdI PhI	0 1 1 1 1 0 1 1 0 1 1 1 1 1 1 1 1 1 2 2 2 2 2 2 2 2 2 1 1 1 1 1 1 1 1 1 2 2 0 2 2 2 2 2 2		Flipped Triad fpi13 BC ₈ H ₃ fp ₃ sm6=45H Not Flipped Triad fpi14 BC ₈ H ₃ fp ₃ sm7=46H	$(2, 5, 2), (1, 3, 4), (1, 7, 6), (1, 2, 5), (1, 4, 3), (1, 7, 6), (2, 3, 4), (2, 4, 7), (3, 5, 7), (4, 6, 5), (2, 3, 7), (2, 4, 8), (3, 5, 4), (4, 7, 8), (1, 2, 5, 3, 4, 7, 6), (1, 0, 1, 0, 0, 1)$
135	$d \sim 1/3$ $c \sim m$ R		{BC8, H140, duaSub24, 24ceH140, Hamming, Idempot}	Ogggsse 010011111 ₂	BaI E8I WdI PhI	0 1 1 1 1 0 1 1 0 1 1 1 1 1 1 1 1 1 2 2 2 2 2 2 2 2 2 1 1 1 1 1 1 1 1 1 2 2 0 2 2 2 2 2 2		Flipped Triad fpi11 BC ₈ H ₃ fp ₃ sm1=43H Not Flipped Triad fpi10 BC ₈ H ₃ fp ₃ sm5=30H	$(2, 5, 2), (1, 3, 4), (1, 7, 6), (1, 2, 5), (1, 4, 3), (1, 7, 6), (2, 3, 4), (2, 4, 7), (3, 5, 7), (4, 6, 5), (2, 3, 7), (2, 4, 8), (3, 5, 4), (4, 7, 8), (1, 2, 5, 3, 4, 7, 6), (1, 0, 1, 0, 0, 1)$
136	$u \sim 2/3$ $b \sim 1$ R		{BC8, 6Cube, H4, snub24, abSub24, ceH8, 24ceH14, Hamming}	Ogggsse 001010111 ₂	BaI E8I WdI PhI	0 1 1 1 0 0 0 1 0 1 1 1 1 1 1 1 1 1 2 2 2 2 2 2 2 2 2 1 1 1 1 1 1 1 1 1 2 2 0 2 2 2 2 2 2		Flipped Triad fpi13 BC ₈ H ₃ fp ₃ sm6=23H Not Flipped Triad fpi14 BC ₈ H ₃ fp ₃ sm7=20H	$(2, 5, 2), (1, 4, 3), (1, 6, 7), (1, 2, 5), (1, 3, 4), (1, 6, 7), (2, 3, 4), (2, 4, 7), (3, 7, 5), (4, 5, 6), (2, 3, 7), (2, 4, 8), (3, 6, 5), (4, 5, 6, 7), (1, 2, 5, 3, 4, 6, 7), (1, 1, 0, 0, 0, 1, 0)$

165		$\frac{0}{a} \frac{0}{b} \frac{0}{c} \frac{0}{d} \frac{0}{e} \frac{0}{f}$	[DK, E7, D4, F4, H4, snub24, snub24ER, snub24H4]	Ouggssce 010000101 ₂	Bnf ERI Phi	1 0 0	1 0 0	1 0 0	1 0 0	0 0 0	1 2 1	0 1 1	0 1 1			Flipped Triad sp1=2 D ₆ H # fp_snm8=64H [1, 2, 3], (1, 5, 4), (1, 6, 7), (2, 7, 4), (2, 5, 6), (3, 6, 4), (3, 7, 5) [2, 6, 4], (2, 5, 7), (3, 7, 4), (3, 6)	Not Flipped Triad sp1=1 D ₆ H # fp_snm5=69H [1, 2, 3], (1, 4, 5), (1, 6, 7), (2, 5, 7), (3, 7, 4), (3, 6)				
166		$\frac{0}{a} \frac{0}{b} \frac{0}{c} \frac{0}{d} \frac{0}{e} \frac{0}{f}$	[DK, D7, D4, F4, H4, dualSnub24, snub24H4, G2a]	Ouggssce 010001110 ₂	Bnf ERI Phi	1 0 0	1 0 0	1 0 0	1 0 0	0 0 0	1 -1 -sqrt(2)	0 0 0	0 1 0			Flipped Triad sp1=5 D ₆ H # fp_snm7=46H [1, 2, 3], (1, 7, 4), (1, 6, 5), (2, 4, 5), (2, 6, 7), (3, 4, 6), (3, 7, 5) [2, 5, 4], (2, 6, 7), (3, 4, 7), (3, 6)	Not Flipped Triad sp1=3 D ₆ H # fp_snm4=47H [1, 2, 3], (1, 4, 7), (1, 5, 7), (2, 4, 5), (2, 6, 7), (3, 4, 7), (3, 6)				
167		$\frac{0}{a} \frac{0}{b} \frac{0}{c} \frac{0}{d} \frac{0}{e} \frac{0}{f}$	[DK, D4, F4, H4, dualSnub24, snub24H4, G2a]	Ouggssce 010001111 ₂	Bnf ERI Phi	1 0 0	1 0 0	1 0 0	1 0 0	0 0 0	0 -1 -sqrt(3)/2	0 0 0	1 2 3	4 2 4	5 3 1			Flipped Triad sp1=9 D ₆ H # fp_snm6=45H [1, 4, 2], (1, 3, 6), (1, 7, 5), (2, 3, 5), (2, 6, 7), (3, 4, 7), (4, 6, 5) [2, 4, 6], (2, 5, 7), (3, 4, 5), (3, 7)	Not Flipped Triad sp1=6 D ₆ H # fp_snm6=45H [1, 2, 3], (1, 4, 7), (1, 5, 7), (2, 3, 5), (2, 6, 7), (3, 4, 7), (3, 6)		
168		$\frac{0}{a} \frac{0}{b} \frac{0}{c} \frac{0}{d} \frac{0}{e} \frac{0}{f}$	[DK, D4, F4, H4, snub24, snub24ER, snub24H4]	Ouggssce 010000110 ₂	Bnf ERI Phi	1 0 0	1 0 0	1 0 0	1 0 0	0 0 0	2 -1 -sqrt(3)	0 1 1	0 1 1	0 1 1			Flipped Triad sp1=5 D ₆ H # fp_snm7=68H [1, 2, 3], (1, 7, 4), (1, 5, 6), (2, 5, 4), (2, 6, 7), (3, 6, 4), (3, 7, 5) [2, 4, 6], (2, 5, 7), (3, 4, 7), (3, 6)	Not Flipped Triad sp1=3 D ₆ H # fp_snm4=62H [1, 2, 3], (1, 4, 7), (1, 5, 7), (2, 5, 4), (2, 6, 7), (3, 4, 7), (3, 6)			
169		$\frac{0}{a} \frac{0}{b} \frac{0}{c} \frac{0}{d} \frac{0}{e} \frac{0}{f}$	[DK, D7, D4, F4, H4, snub24, snub24ER, snub24H4]	Ouggssce 010000111 ₂	Bnf ERI Phi	1 0 0	1 0 0	1 0 0	1 0 0	0 0 0	2 sqrt(3)	0 -sqrt(3)	1 0 0	0 1 0			Flipped Triad sp1=9 D ₆ H # fp_snm6=68H [1, 2, 3], (1, 4, 7), (1, 5, 6), (2, 5, 4), (2, 6, 7), (3, 7, 4), (4, 6, 5) [2, 4, 6], (2, 5, 7), (3, 5, 4), (3, 7)	Not Flipped Triad sp1=6 D ₆ H # fp_snm6=68H [1, 2, 3], (1, 4, 7), (1, 5, 6), (2, 5, 4), (2, 6, 7), (3, 7, 4), (3, 6)			
170		$\frac{0}{a} \frac{0}{b} \frac{0}{c} \frac{0}{d} \frac{0}{e} \frac{0}{f}$	[DK, E7, D7, D6, D4, F4, H4, snub24, snub24ER, snub24H4]	Ouggssce 010000001 ₂	Bnf ERI Phi	1 0 0	1 0 0	1 0 0	1 0 0	0 0 0	1 -1 -sqrt(3)	0 1 1	0 -1 1	0 1 1			Flipped Triad sp1=2 D ₆ H # fp_snm8=74H [1, 2, 3], (1, 4, 5), (1, 7, 6), (2, 4, 7), (2, 6, 5), (3, 6, 4), (3, 7, 5) [2, 4, 6], (2, 7, 5), (3, 7, 4), (3, 6)	Not Flipped Triad sp1=1 D ₆ H # fp_snm5=77H [1, 2, 3], (1, 4, 7), (1, 5, 6), (2, 4, 7), (2, 6, 5), (3, 6, 4), (3, 7, 5)			
171		$\frac{0}{a} \frac{0}{b} \frac{0}{c} \frac{0}{d} \frac{0}{e} \frac{0}{f}$	[DK, D7, D4, F4, H4, snub24, snub24ER, snub24H4]	Ouggssce 010000101 ₂	Bnf ERI Phi	1 0 0	1 0 0	1 0 0	1 0 0	0 0 0	1 -1 -sqrt(3)	1 -1 1	0 1 1	0 1 1			Flipped Triad sp1=5 D ₆ H # fp_snm7=75H [1, 2, 3], (1, 4, 7), (1, 6, 5), (2, 4, 5), (2, 7, 6), (3, 6, 4), (3, 7, 5) [2, 4, 6], (2, 7, 5), (3, 7, 4), (3, 6)	Not Flipped Triad sp1=3 D ₆ H # fp_snm4=77H [1, 2, 3], (1, 4, 7), (1, 5, 6), (2, 4, 7), (2, 6, 5), (3, 6, 4), (3, 7, 5)			
172		$\frac{0}{a} \frac{0}{b} \frac{0}{c} \frac{0}{d} \frac{0}{e} \frac{0}{f}$	[DK, D4, F4, H4, snub24, snub24ER, snub24H4]	Ouggssce 010000111 ₂	Bnf ERI Phi	1 0 0	1 0 0	1 0 0	1 0 0	0 0 0	1 -sqrt(3)	0 -sqrt(2)	0 -sqrt(3)	1 0 0			Flipped Triad sp1=9 D ₆ H # fp_snm6=76H [1, 2, 3], (1, 6, 4), (1, 7, 5), (2, 3, 5), (2, 7, 6), (3, 7, 4), (4, 6, 5) [2, 4, 6], (2, 7, 5), (3, 5, 4), (3, 7)	Not Flipped Triad sp1=6 D ₆ H # fp_snm6=76H [1, 2, 3], (1, 4, 7), (1, 5, 6), (2, 3, 5), (2, 6, 7), (3, 7, 4), (3, 6)			
173		$\frac{0}{a} \frac{0}{b} \frac{0}{c} \frac{0}{d} \frac{0}{e} \frac{0}{f}$	[DK, D4, F4, H4, snub24, snub24ER, snub24H4]	Ouggssce 000001101 ₂	Bnf ERI Phi	1 0 0	1 0 0	1 0 0	1 0 0	0 0 0	1 sqrt(3)	0 sqrt(2)	0 sqrt(3)	1 0 0			Flipped Triad sp1=6 D ₆ H # fp_snm6=24H [1, 2, 3], (1, 4, 7), (1, 6, 5), (2, 4, 6), (2, 5, 7), (3, 5, 4), (3, 6, 7) [2, 3, 5], (2, 6, 7), (3, 7, 4), (4, 5)	Not Flipped Triad sp1=9 D ₆ H # fp_snm6=24H [1, 2, 3], (1, 4, 7), (1, 5, 6), (2, 4, 6), (2, 5, 7), (3, 5, 4), (3, 6, 7)			
174		$\frac{0}{a} \frac{0}{b} \frac{0}{c} \frac{0}{d} \frac{0}{e} \frac{0}{f}$	[DK, D7, D4, F4, H4, snub24, snub24ER, snub24H4]	Ouggssce 000001101 ₂	Bnf ERI Phi	1 0 0	1 0 0	1 0 0	1 0 0	0 0 0	1 sqrt(3)	1 sqrt(2)	-1 -sqrt(6)	0 1 0			Flipped Triad sp1=3 D ₆ H # fp_snm4=22H [1, 2, 3], (1, 6, 4), (1, 7, 5), (2, 5, 4), (2, 6, 7), (3, 7, 4), (3, 5, 6) [2, 4, 7], (2, 5, 4), (2, 6, 7), (3, 6, 4), (3, 5)	Not Flipped Triad sp1=5 D ₆ H # fp_snm7=27H [1, 2, 3], (1, 4, 5), (1, 7, 6), (2, 5, 4), (2, 6, 7), (3, 7, 4), (3, 6)			
175		$\frac{0}{a} \frac{0}{b} \frac{0}{c} \frac{0}{d} \frac{0}{e} \frac{0}{f}$	[DK, E7, D7, D6, D4, F4, H4, DS, H4, 24cell, 16Cstl, altSnub24, snub24ER, snub24H4]	Ouggssce 000001001 ₂	Bnf ERI Phi	1 0 0	1 0 0	1 0 0	1 0 0	0 0 0	1 sqrt(3)	-1 -sqrt(2)	-1 -sqrt(6)	1 1 1			Flipped Triad sp1=9 D ₆ H # fp_snm5=25H [1, 2, 3], (1, 4, 5), (1, 7, 6), (2, 4, 6), (2, 5, 7), (3, 7, 4), (3, 5, 6) [2, 4, 7], (2, 5, 4), (2, 6, 7), (3, 6, 4), (3, 5)	Not Flipped Triad sp1=2 D ₆ H # fp_snm8=26H [1, 2, 3], (1, 4, 7), (1, 5, 6), (2, 4, 6), (2, 5, 7), (3, 7, 4), (3, 6)			
176		$\frac{0}{a} \frac{0}{b} \frac{0}{c} \frac{0}{d} \frac{0}{e} \frac{0}{f}$	[DK, E7, D7, E6, D6, DS, H4, 24cell, 16Cstl, altSnub24, snub24ER, snub24H4]	Ouggssce 011100100 ₂	Bnf ERI Phi	1 0 0	1 0 0	1 0 0	1 0 0	0 -1 0	0 sqrt(2)	0 0	0 0	0 1 0			Flipped Triad sp1=16 D ₆ H # fp_snm3=64H [1, 2, 5], (1, 3, 6), (1, 7, 4), (2, 3, 7), (2, 4, 6), (3, 5, 4), (3, 7, 5), (4, 5, 6) [2, 4, 7], (2, 5, 4), (2, 6, 7), (3, 6, 4), (4, 6)	Not Flipped Triad sp1=5 D ₆ H # fp_snm3=64H [1, 2, 5], (1, 3, 6), (1, 7, 4), (2, 3, 7), (2, 4, 6), (3, 5, 4), (3, 7, 5), (4, 6)			
177		$\frac{-1/3}{a} \frac{0}{b} \frac{0}{c} \frac{0}{d} \frac{0}{e} \frac{0}{f}$	[DK, E7, D7, D6, H4, snub24, altSnub24, snub24ER, snub24H4]	Ouggssce 000100001 ₂	Bnf ERI Phi	1 0 0	1 0 0	1 0 0	1 0 0	0 -1 0	0 -1 -sqrt(3)	0 1 1	0 1 1	0 1 1			Flipped Triad sp1=17 D ₆ H # fp_snm8=60H [1, 5, 2], (1, 7, 3), (1, 4, 6), (2, 4, 3), (2, 6, 7), (3, 5, 6), (4, 5, 7) [2, 3, 5], (2, 4, 7), (2, 4, 3), (3, 6, 7), (4, 5)	Not Flipped Triad sp1=9 D ₆ H # fp_snm3=62H [1, 2, 6], (1, 4, 7), (1, 5, 7), (2, 4, 3), (2, 6, 7), (3, 5, 6), (4, 5, 7) [2, 4, 3], (3, 6, 7), (3, 6, 7), (4, 5)			
178		$\frac{-1/3}{a} \frac{0}{b} \frac{0}{c} \frac{0}{d} \frac{0}{e} \frac{0}{f}$	[DS, D7, H4, dualSnub24, snub24H4]	Ouggssce 000100010 ₂	Bnf ERI Phi	1 0 0	1 0 0	1 0 0	1 0 0	0 0 0	1 -sqrt(2)	-1 -sqrt(2)	1 -sqrt(3)	1 -sqrt(2)	1 sqrt(6)			Flipped Triad sp1=18 D ₆ H # fp_snm6=69H [1, 5, 2], (1, 3, 7), (1, 4, 6), (2, 6, 3), (2, 4, 7), (3, 4, 5), (5, 6, 7) [2, 4, 3], (2, 4, 3), (3, 5, 6), (4, 6)	Not Flipped Triad sp1=20 D ₆ H # fp_snm1=60H [1, 5, 2], (1, 3, 7), (1, 4, 6), (2, 6, 3), (2, 4, 7), (3, 4, 5), (5, 6, 7) [2, 4, 3], (2, 4, 3), (3, 5, 6), (4, 6)		

Seq #	Symbol	2D/3D Shape	Groups	Particle Quantum Bits	Binary / ER / Physics Coordinates	Algebra Root Weight / Height / RZ/Atomic Element Number -->	Ele #	Octonions
207	c_{14}^0		[D8, E7, D7, E6, D6, E5, D5, E4, D4, F4, H4, sub24H4, sub24H4, D3, D3]	00ggssse 00100010 ₂	BnI: 0 1 1 0 1 0 1 1 ER: 1 0 -1 0 0 0 0 0 Ph: 1 0 -1/√2 -1/√2 0 0 0 0	Flipped Triad spin5 D ₈ H ₈ fp_sml7→0DH [1, 3, 2), (1, 4, 7), (1, 6, 5), (2, 5, 4), (2, 6, 7), (3, 4, 6), (3, 5, 7), (2, 4, 5), (2, 6, 5), (2, 6, 7), (3, 4, 7), (3, 5, 6), (0, 1, 0, 0, 0, 0)]	Not Flipped Triad spin3 D ₈ H ₈ fp_sml4→04H [1, 2, 3), (1, 4, 6), (1, 7, 5), (2, 5, 4), (2, 6, 7), (3, 4, 7), (3, 5, 6), (0, 1, 0, 0, 0, 0)]	
208	c_{14}^0		[D8, E7, D7, E6, D6, E5, D5, D4, F4, H4, sub24H4]	00ggssse 01100011 ₂	BnI: 0 1 1 0 0 1 1 1 ER: 1 0 0 -1 0 0 0 0 Ph: 1 0 0 1/√2 -1/√2 0 0 0	Flipped Triad spin6 D ₈ H ₈ fp_sml6→6FH [1, 2, 6), (1, 7, 4), (1, 6, 5), (2, 6, 4), (2, 5, 7), (3, 5, 4), (3, 7, 6), (2, 5, 3), (2, 6, 7), (3, 7, 4), (4, 6, 5), (1, 1, 1, 0, 1, 1)]	Not Flipped Triad spin9 D ₈ H ₈ fp_sml6→6FH [1, 2, 5), (1, 6, 3), (1, 7, 5), (2, 6, 4), (2, 5, 7), (3, 5, 4), (3, 7, 6), (2, 4, 5), (2, 6, 7), (3, 7, 4), (4, 6, 5), (1, 1, 1, 0, 1, 1)]	
209	c_{14}^0		[D8, E7, D7, E6, D6, D5, H4, 24cH, 16cH, dualSub24, dualSub24, 24cH14, 16cH14]	00ggssse 01010100 ₂	BnI: 0 1 0 0 1 1 1 0 ER: 1 0 0 0 -1 0 0 0 Ph: 1 0 0 0 0 -1 0 0	Flipped Triad spin15 D ₈ H ₈ fp_sml3→4EH [1, 2, 6), (1, 3, 4), (1, 5, 7), (2, 4, 3), (2, 6, 7), (3, 5, 7), (4, 6, 5), (2, 7, 3), (2, 4, 6), (3, 4, 5), (5, 7, 6), (0, 1, 1, 0, 0, 1)]	Not Flipped Triad spin16 D ₈ H ₈ fp_sml3→4EH [1, 2, 5), (1, 6, 3), (1, 7, 4), (2, 4, 3), (2, 5, 7), (3, 5, 4), (3, 7, 6), (2, 4, 5), (2, 6, 7), (3, 7, 4), (4, 6, 5), (0, 1, 1, 0, 0, 1)]	
210	$c_{14}^{2/3}$		[D8, E7, D7, D6, H4, dualSub24, dualSub24, 24cH14, 16cH14, sub24H4]	00ggssse 00100100 ₂	BnI: 0 1 0 0 1 1 1 0 ER: 1 0 0 0 0 -1 0 0 Ph: 1 0 0 0 0 -1/√3 1/√2 1/√6	Flipped Triad spin19 D ₈ H ₈ fp_sml3→28H [1, 2, 6), (1, 3, 4), (1, 5, 7), (2, 5, 3), (2, 4, 7), (3, 7, 6), (4, 5, 6), (2, 3, 4), (2, 6, 7), (3, 6, 5), (4, 5, 7), (0, 0, 0, 1, 0, 1, 0)]	Not Flipped Triad spin17 D ₈ H ₈ fp_sml8→21H [1, 2, 5), (1, 6, 3), (1, 7, 4), (2, 5, 3), (2, 4, 7), (3, 7, 6), (4, 5, 6), (2, 3, 4), (2, 6, 7), (3, 6, 5), (4, 5, 7), (0, 0, 0, 1, 0, 1, 0)]	
211	$c_{14}^{2/3}$		[D8, E7, D7, D6, dualSub24, dualSub24, sub24H4]	00ggssse 00100100 ₂	BnI: 0 1 0 0 1 1 1 0 ER: 1 0 0 0 0 -1 0 0 Ph: 1 0 0 0 0 -1/√3 -1/√2 1/√6	Flipped Triad spin20 D ₈ H ₈ fp_sml1→2AH [1, 2, 6), (1, 4, 3), (1, 5, 7), (2, 7, 3), (2, 4, 5), (3, 6, 5), (4, 6, 5), (2, 3, 4), (2, 6, 7), (3, 5, 4), (5, 6, 7), (0, 1, 0, 1, 0, 1, 0)]	Not Flipped Triad spin18 D ₈ H ₈ fp_sml6→23H [1, 2, 5), (1, 6, 3), (1, 7, 4), (2, 5, 3), (2, 4, 7), (3, 7, 6), (4, 5, 6), (2, 3, 4), (2, 6, 7), (3, 6, 5), (4, 5, 7), (0, 1, 0, 1, 0, 1, 0)]	
212	$c_{14}^{2/3}$		[D8, H4, dualSub24, sub24H4]	00ggssse 00100110 ₂	BnI: 0 1 0 0 1 0 1 1 ER: 1 0 0 0 0 0 -1 0 Ph: 1 0 0 0 0 -1/√3 0 -1/√3	Flipped Triad spin21 D ₈ H ₈ fp_sml6→23H [1, 2, 6), (1, 5, 3), (1, 4, 7), (2, 3, 4), (2, 5, 7), (3, 7, 6), (4, 5, 6), (2, 3, 4), (2, 6, 7), (3, 6, 5), (4, 5, 7), (1, 1, 0, 0, 0, 1, 0)]	Not Flipped Triad spin22 D ₈ H ₈ fp_sml6→23H [1, 2, 5), (1, 6, 3), (1, 7, 4), (2, 5, 3), (2, 4, 7), (3, 7, 6), (4, 5, 6), (2, 3, 4), (2, 6, 7), (3, 6, 5), (4, 5, 7), (1, 1, 0, 0, 0, 1, 0)]	
213	$c_{14}^{1/3}$		[D8, H4, dualSub24, sub24H4]	00ggssse 01010111 ₂	BnI: 0 1 0 0 0 1 1 1 ER: 1 0 0 0 0 0 1 0 Ph: 1 0 0 0 0 1/√3 0 1/√3	Flipped Triad spin21 D ₈ H ₈ fp_sml6→45H [1, 2, 6), (1, 3, 5), (1, 7, 4), (2, 3, 4), (2, 5, 7), (3, 7, 6), (4, 5, 6), (2, 3, 4), (2, 6, 7), (3, 6, 5), (4, 5, 7), (1, 0, 1, 0, 0, 1, 0)]	Not Flipped Triad spin22 D ₈ H ₈ fp_sml6→45H [1, 2, 5), (1, 6, 3), (1, 7, 4), (2, 5, 3), (2, 4, 7), (3, 7, 6), (4, 5, 6), (2, 3, 4), (2, 6, 7), (3, 6, 5), (4, 5, 7), (1, 0, 1, 0, 0, 1, 0)]	
214	$c_{14}^{1/3}$		[D8, E7, H4, dualSub24, sub24H4]	00ggssse 01010110 ₂	BnI: 0 0 0 1 1 1 1 0 ER: 1 0 0 0 0 1 0 0 Ph: 1 0 0 0 0 1/√3 1/√2 -1/√6	Flipped Triad spin20 D ₈ H ₈ fp_sml1→4CH [1, 2, 6), (1, 4, 3), (1, 5, 7), (2, 7, 3), (2, 4, 5), (3, 6, 5), (4, 6, 5), (2, 3, 4), (2, 6, 7), (3, 5, 4), (5, 6, 7), (0, 1, 0, 0, 0, 1, 0)]	Not Flipped Triad spin18 D ₈ H ₈ fp_sml6→45H [1, 2, 5), (1, 6, 3), (1, 7, 4), (2, 5, 3), (2, 4, 7), (3, 7, 6), (4, 5, 6), (2, 3, 4), (2, 6, 7), (3, 6, 5), (4, 5, 7), (0, 1, 0, 0, 0, 1, 0)]	
215	$c_{14}^{1/3}$		[D8, E7, D7, D6, H4, dualSub24, sub24H4]	00ggssse 01010110 ₂	BnI: 0 0 0 1 1 1 1 0 ER: 1 0 0 0 0 1 0 0 Ph: 1 0 0 0 0 1/√3 -1/√2 -1/√6	Flipped Triad spin19 D ₈ H ₈ fp_sml3→4EH [1, 2, 6), (1, 4, 3), (1, 5, 7), (2, 5, 3), (2, 4, 7), (3, 7, 6), (4, 5, 6), (2, 3, 4), (2, 6, 7), (3, 6, 5), (4, 5, 7), (0, 1, 1, 0, 0, 1, 0)]	Not Flipped Triad spin17 D ₈ H ₈ fp_sml8→47H [1, 2, 5), (1, 6, 3), (1, 7, 4), (2, 5, 3), (2, 4, 7), (3, 7, 6), (4, 5, 6), (2, 3, 4), (2, 6, 7), (3, 6, 5), (4, 5, 7), (0, 1, 1, 0, 0, 1, 0)]	
216	c_{14}^0		[D8, E7, D7, E6, D6, D5, H4, sub24, abSub24, sub24H4, 24cH14, 16cH14]	00ggssse 00101000 ₂	BnI: 0 0 0 1 1 1 0 0 ER: 1 0 0 0 0 1 0 0 Ph: 1 0 0 0 0 1 0 0	Flipped Triad spin9 D ₈ H ₈ fp_sml6→0EH [1, 2, 4), (1, 6, 3), (1, 7, 5), (2, 5, 3), (2, 6, 7), (3, 4, 7), (4, 5, 6), (2, 3, 4), (2, 5, 7), (3, 4, 5), (3, 6, 5), (0, 0, 0, 1, 0, 0, 0)]	Not Flipped Triad spin9 D ₈ H ₈ fp_sml6→0EH [1, 2, 3), (1, 4, 7), (1, 6, 5), (2, 5, 3), (2, 6, 7), (3, 4, 7), (4, 5, 6), (2, 3, 4), (2, 5, 7), (3, 4, 5), (3, 6, 5), (0, 1, 1, 0, 0, 0, 0)]	
217	c_{14}^0		[D8, E7, D7, E6, D6, E5, D5, D4, F4, H4, sub24H4]	00ggssse 00100001 ₂	BnI: 0 0 0 1 1 0 1 1 ER: 1 0 0 1 0 0 0 0 Ph: 1 0 0 -1/√2 1/√2 0 0 0	Flipped Triad spin2 D ₈ H ₈ fp_sml5→21H [1, 3, 2), (1, 4, 5), (1, 6, 7), (2, 4, 7), (2, 5, 6), (3, 6, 4), (3, 5, 7), (2, 4, 6), (2, 5, 7), (3, 7, 4), (3, 5, 6), (0, 1, 0, 0, 0, 1, 0)]	Not Flipped Triad spin10 BC ₈ H ₈ fp_sml5→6EH [1, 2, 3), (1, 4, 7), (1, 6, 5), (2, 4, 7), (2, 5, 6), (3, 6, 4), (3, 5, 7), (2, 4, 6), (2, 5, 7), (3, 4, 5), (3, 6, 5), (0, 1, 0, 0, 0, 1, 0)]	
218	c_{14}^0		[D8, E7, D7, E6, D6, E5, D5, E4, D4, F4, H4, sub24H4, D3, D3]	00ggssse 00100100 ₂	BnI: 0 0 0 1 0 1 1 1 ER: 1 0 0 1 0 0 0 0 Ph: 1 0 0 1/√2 1/√2 0 0 0	Flipped Triad spin8 BC ₈ H ₈ fp_sml2→67H [1, 3, 2), (1, 3, 6), (1, 7, 5), (2, 3, 7), (2, 5, 6), (3, 6, 4), (4, 7, 5), (2, 3, 4), (2, 5, 4), (2, 6, 7), (3, 6, 5), (4, 7, 6), (0, 1, 0, 0, 0, 1, 0)]	Not Flipped Triad spin10 BC ₈ H ₈ fp_sml5→6EH [1, 2, 3), (1, 4, 7), (1, 6, 5), (2, 4, 7), (2, 5, 6), (3, 6, 4), (3, 5, 7), (2, 4, 6), (2, 5, 7), (3, 4, 5), (3, 6, 5), (0, 1, 0, 0, 0, 1, 0)]	
219	c_{14}^0		[D8, E7, D7, E6, D6, E5, D5, E4, D4, F4, H4, sub24H4, D3, D3, D3]	00ggssse 00100101 ₂	BnI: 0 0 0 0 1 1 1 1 ER: 1 1 0 0 0 0 0 0 Ph: 1 1 0 0 0 0 0 0	Flipped Triad spin9 D ₈ H ₈ fp_sml6→3DH [1, 4, 2), (1, 3, 6), (1, 7, 5), (2, 5, 3), (2, 7, 6), (3, 7, 4), (4, 5, 6), (2, 3, 4), (2, 7, 5), (3, 5, 4), (3, 6, 5), (1, 0, 1, 1, 1, 1, 0)]	Not Flipped Triad spin10 D ₈ H ₈ fp_sml6→3DH [1, 2, 3), (1, 4, 7), (1, 6, 5), (2, 5, 3), (2, 7, 6), (3, 7, 4), (4, 5, 6), (2, 3, 4), (2, 7, 5), (3, 5, 4), (3, 6, 5), (1, 0, 1, 1, 1, 1, 0)]	
220	$c_{14}^{-2/3}$		[D8, E7, 6Cub, C4, H4, dualSub24, sub24H4]	00ggssse 01101010 ₂	BnI: 1 1 1 1 1 1 0 0 ER: 1 1 1 1 1 1 1 1 Ph: 2 2 2 2 2 2 2 2	Flipped Triad spin8 BC ₈ H ₈ fp_sml2→67H [1, 3, 2), (1, 3, 6), (1, 7, 5), (2, 3, 7), (2, 5, 6), (3, 6, 4), (4, 7, 5), (2, 3, 4), (2, 5, 4), (2, 6, 7), (3, 6, 5), (4, 7, 6), (1, 2, 4, 6, 3, 7, 5), (1, 1, 0, 0, 1, 1)]	Not Flipped Triad spin10 BC ₈ H ₈ fp_sml5→6EH [1, 2, 3), (1, 4, 7), (1, 6, 5), (2, 4, 7), (2, 5, 6), (3, 6, 4), (3, 5, 7), (2, 4, 6), (2, 5, 7), (3, 4, 5), (3, 6, 5), (0, 1, 1, 0, 1, 1)]	

pascalRow#7

221	$\frac{-2/3}{b_1 R}$		{BCR, 6Cube, H140, dualSub24, snub24H140}	Oppgssse 01101010 ₂	Ba1 E81 W1 Ph1	1 1 1 1 1 0 1 0 1 1 1 1 1 1 1 1 2 2 2 2 2 2 2 2 1 1 1 1 1 1 1 1 2 2 0 1 1 1 1 1 2 2 2 2 2 2 2 2	Flipped Triad fpin11 BCg H fp_smm1=66H	Not Flipped Triad fpin12 BCg H fp_smm4=65H	Rt Wt Ht	1 2 3 4 1 3 5 2 1 0 0 0 0 -1 0 1 -1 1 21	[3, 2, 4], (1, 7, 3), (1, 6, 5), (2, 3, 5), (2, 6, 7), (3, 6, 4), (4, 7, 5) [2, 3, 6], (2, 4, 7), (3, 5, 4), (4, 7, 5)]	[1, 4, 2, 3, 6, 5] [1, 4, 2, 3, 7, 6, 5] [0, 1, 1, 0, 0, 1, 1]
222	$\frac{-2/3}{b_1 R}$		{BCR, H140, dualSub24, snub24H140}	Oppgssse 01101011 ₂	Ba1 E81 W1 Ph1	1 1 1 1 1 0 0 1 1 1 1 1 1 1 1 1 2 2 2 2 2 2 2 2 1 1 1 1 1 1 1 1 2 2 0 1 1 1 1 1 2 2 2 2 2 2 2 2	Flipped Triad fpin14 BCg H fp_smm7=6CH	Not Flipped Triad fpin13 BCg H fp_smm6=6FH	Rt Wt Ht	0 0 0 0 -1 -1 0 0 1 0 0 0 0 -1 -1 1 0 1 2	[3, 2, 5], (1, 3, 4), (1, 7, 6), (2, 7, 3), (2, 4, 6), (3, 6, 5), (4, 7, 5) [2, 3, 6], (2, 4, 7), (3, 7, 5), (4, 6, 7)]	[1, 5, 2, 4, 3, 6, 7] [1, 5, 2, 4, 3, 7, 6] [0, 0, 1, 1, 0, 1, 1]
223	$\frac{-1/3}{d L}$		{BCR, 6Cube, H140, dualSub24, snub24H140}	Oppgssse 00001001 ₂	Ba1 E81 W1 Ph1	1 1 1 1 1 0 1 1 1 1 1 1 1 1 1 1 2 2 2 2 2 2 2 2 1 1 1 1 1 1 1 1 2 2 0 1 1 1 1 1 2 2 2 2 2 2 2 2	Flipped Triad fpin14 BCg H fp_smm7=0AH	Not Flipped Triad fpin13 BCg H fp_smm6=09H	Rt Wt Ht	1 2 3 4 1 3 4 2 1 0 0 0 1 -1 1 -1 0 1 20	[3, 2, 4], (1, 4, 3), (1, 6, 5), (2, 7, 3), (2, 4, 6), (3, 5, 6), (4, 5, 7) [2, 3, 6], (2, 4, 7), (3, 5, 7), (4, 5, 6, 7)]	[1, 5, 2, 4, 3, 6, 7] [1, 5, 2, 4, 3, 6, 7] [0, 1, 0, 1, 0, 0, 0]
224	$\frac{-1/3}{d L}$		{BCR, H140, dualSub24, snub24H140}	Oppgssse 00001001 ₂	Ba1 E81 W1 Ph1	1 1 1 1 1 0 1 0 1 1 1 1 1 1 1 1 2 2 2 2 2 2 2 2 1 1 1 1 1 1 1 1 2 2 0 1 1 1 1 1 2 2 2 2 2 2 2 2	Flipped Triad fpin11 BCg H fp_smm1=00H	Not Flipped Triad fpin12 BCg H fp_smm4=03H	Rt Wt Ht	0 0 0 0 -1 -1 -1 0 1 0 0 0 1 -1 0 -1 1 1 3	[3, 2, 4], (1, 3, 7), (1, 5, 6), (2, 3, 5), (2, 6, 7), (3, 4, 6), (4, 5, 7) [2, 3, 6], (2, 4, 7), (3, 4, 5), (4, 6, 7)]	[1, 4, 2, 3, 7, 5, 6] [1, 4, 2, 3, 7, 6, 5] [0, 0, 0, 0, 0, 0, 0]
225	$\frac{-1/3}{d L}$		{BCR, E7, H140, dualSub24, snub24H140}	Oppgssse 00001000 ₂	Ba1 E81 W1 Ph1	1 1 1 1 1 0 0 1 1 1 1 1 1 1 1 1 2 2 2 2 2 2 2 2 1 1 1 1 1 1 1 1 2 2 0 1 1 1 1 1 2 2 2 2 2 2 2 2	Flipped Triad fpin8 BCg H fp_smm2=01H	Not Flipped Triad fpin10 BCg H fp_smm5=08H	Rt Wt Ht	0 0 0 0 -1 -1 -1 -1 1 0 0 0 1 -1 0 0 -1 1 4	[3, 2, 4], (1, 3, 5), (1, 6, 4), (2, 3, 7), (2, 5, 6), (3, 4, 6), (4, 5, 7) [2, 3, 6], (2, 4, 7), (3, 5, 7), (4, 6, 7)]	[1, 2, 4, 3, 5, 6, 7] [1, 2, 4, 3, 5, 6, 7] [0, 0, 0, 0, 0, 0, 0]
226	$\frac{-1/3}{b_1 R}$		{BCR, 6Cube, H14, sub24, abSub24, ceHE, 24ceH14}	Oppgssse 00011101 ₂	Ba1 E81 W1 Ph1	1 1 1 1 1 0 1 1 1 1 1 1 1 1 1 1 2 2 2 2 2 2 2 2 1 1 1 1 1 1 1 1 2 2 0 1 1 1 1 1 2 2 2 2 2 2 2 2	Flipped Triad fpin20 BCg H fp_smm6=3AH	Not Flipped Triad fpin28 BCg H fp_smm3=21H	Rt Wt Ht	1 2 3 3 1 3 4 2 1 0 0 1 -1 -1 1 0 0 1 19	[3, 2, 7], (1, 4, 3), (1, 4, 6), (2, 3, 5), (2, 6, 4), (3, 7, 4), (5, 6, 7) [2, 3, 6], (2, 4, 5), (3, 7, 4), (5, 6, 7)]	[1, 7, 2, 6, 3, 4, 5] [1, 7, 2, 6, 3, 5, 4] [0, 1, 0, 1, 1, 1, 0]
227	$\frac{-1/3}{b_1 R}$		{BCR, H14, sub24, abSub24, ceHE, snub24H14}	Oppgssse 00011101 ₂	Ba1 E81 W1 Ph1	1 1 1 1 1 0 1 1 1 1 1 1 1 1 1 1 2 2 2 2 2 2 2 2 1 1 1 1 1 1 1 1 2 2 0 1 1 1 1 1 2 2 2 2 2 2 2 2	Flipped Triad fpin27 BCg H fp_smm4=30H	Not Flipped Triad fpin29 BCg H fp_smm7=29H	Rt Wt Ht	0 0 0 -1 -1 -1 -1 0 1 0 0 1 -1 -1 0 0 1 1 4	[3, 2, 7], (1, 3, 5), (1, 4, 6), (2, 3, 4), (2, 6, 5), (3, 7, 6), (4, 5, 7) [2, 3, 6], (2, 4, 5), (3, 7, 5), (4, 6, 7)]	[1, 7, 2, 6, 3, 4, 5] [1, 7, 2, 6, 3, 4, 5] [0, 0, 0, 1, 1, 1, 0]
228	$\frac{-1/3}{b_1 R}$		{BCR, E7, H14, dualSub24, snub24H14}	Oppgssse 00011101 ₂	Ba1 E81 W1 Ph1	1 1 1 1 1 0 1 1 1 1 1 1 1 1 1 1 2 2 2 2 2 2 2 2 1 1 1 1 1 1 1 1 2 2 0 1 1 1 1 1 2 2 2 2 2 2 2 2	Flipped Triad fpin25 BCg H fp_smm5=3BH	Not Flipped Triad fpin26 BCg H fp_smm8=28H	Rt Wt Ht	0 0 0 -1 -1 -1 -1 -1 1 0 0 1 -1 -1 0 1 -1 1 5	[3, 2, 7], (1, 4, 3), (1, 5, 6), (2, 3, 5), (2, 6, 4), (3, 7, 6), (4, 5, 7) [2, 3, 6], (2, 4, 5), (3, 7, 5), (4, 6, 7)]	[1, 2, 7, 4, 3, 5, 6] [1, 2, 7, 4, 3, 5, 6] [0, 0, 0, 1, 1, 1, 0]
229	$\frac{-1/3}{r L}$		{BCR, E7, E6, H14, sub24, abSub24, ceHE, snub24H14}	Oppgssse 00011100 ₂	Ba1 E81 W1 Ph1	1 1 1 1 1 0 0 1 1 1 1 1 1 1 1 1 2 2 2 2 2 2 2 2 1 1 1 1 1 1 1 1 2 2 0 1 1 1 1 1 2 2 2 2 2 2 2 2	Flipped Triad fpin24 BCg H fp_smm3=31H	Not Flipped Triad fpin23 BCg H fp_smm2=22H	Rt Wt Ht	0 0 0 -1 -1 -1 -2 -1 1 0 0 1 0 -1 1 -1 0 1 6	[3, 2, 4], (1, 3, 7), (1, 5, 4), (2, 3, 5), (2, 7, 4), (3, 6, 4), (5, 6, 7) [2, 3, 6], (2, 4, 5), (3, 6, 5), (4, 6, 7)]	[1, 2, 6, 3, 7, 4, 5] [1, 2, 6, 3, 7, 4, 5] [0, 1, 0, 0, 1, 1, 0]
230	$\frac{-1/3}{b_1 R}$		{BCR, 6Cube, H140, dualSub24, snub24H140}	Oppgssse 00011101 ₂	Ba1 E81 W1 Ph1	1 1 1 1 1 0 1 1 1 1 1 1 1 1 1 1 2 2 2 2 2 2 2 2 1 1 1 1 1 1 1 1 2 2 0 1 1 1 1 1 2 2 2 2 2 2 2 2	Flipped Triad fpin30 BCg H fp_smm6=24H	Not Flipped Triad fpin25 BCg H fp_smm2=25H	Rt Wt Ht	1 2 2 3 1 3 4 2 1 0 1 -1 0 -1 1 0 0 1 18	[3, 2, 7], (1, 3, 6), (1, 5, 4), (2, 3, 5), (2, 4, 6), (3, 7, 4), (5, 6, 7) [2, 3, 6], (2, 4, 5), (3, 7, 4), (5, 6, 7)]	[1, 7, 2, 6, 3, 4, 5] [1, 7, 2, 6, 3, 4, 5] [0, 0, 1, 0, 0, 1, 0]
231	$\frac{-1/3}{b_1 R}$		{BCR, H14, sub24, abSub24, snub24H14, 24ceH14}	Oppgssse 00011101 ₂	Ba1 E81 W1 Ph1	1 1 1 1 1 0 1 1 1 1 1 1 1 1 1 1 2 2 2 2 2 2 2 2 1 1 1 1 1 1 1 1 2 2 0 1 1 1 1 1 2 2 2 2 2 2 2 2	Flipped Triad fpin27 BCg H fp_smm4=2EH	Not Flipped Triad fpin29 BCg H fp_smm7=27H	Rt Wt Ht	0 0 -1 -1 -1 -1 -1 0 1 0 1 -1 0 -1 0 0 1 1 5	[3, 2, 7], (1, 3, 5), (1, 6, 4), (2, 4, 3), (2, 5, 6), (3, 7, 6), (4, 5, 7) [2, 3, 6], (2, 4, 5), (3, 7, 5), (4, 6, 7)]	[1, 7, 2, 6, 3, 4, 5] [1, 7, 2, 6, 3, 4, 5] [0, 1, 1, 0, 0, 1, 0]
232	$\frac{-1/3}{b_1 R}$		{BCR, E7, H14, sub24, abSub24, snub24H14, 24ceH14}	Oppgssse 00011100 ₂	Ba1 E81 W1 Ph1	1 1 1 1 1 0 1 1 1 1 1 1 1 1 1 1 2 2 2 2 2 2 2 2 1 1 1 1 1 1 1 1 2 2 0 1 1 1 1 1 2 2 2 2 2 2 2 2	Flipped Triad fpin25 BCg H fp_smm5=25H	Not Flipped Triad fpin26 BCg H fp_smm8=26H	Rt Wt Ht	0 0 -1 -1 -1 -1 -1 -1 1 0 1 -1 0 -1 0 1 -1 1 6	[3, 2, 7], (1, 3, 4), (1, 6, 5), (2, 3, 5), (2, 4, 6), (3, 7, 6), (4, 5, 7) [2, 3, 6], (2, 4, 5), (3, 7, 5), (4, 6, 7)]	[1, 2, 7, 4, 3, 6, 5] [1, 2, 7, 4, 3, 6, 5] [0, 1, 0, 0, 1, 0]
233	$\frac{-1/3}{r L}$		{BCR, E7, E6, H14, sub24, abSub24, snub24H14, 24ceH14}	Oppgssse 00011100 ₂	Ba1 E81 W1 Ph1	1 1 1 1 1 0 0 1 1 1 1 1 1 1 1 1 2 2 2 2 2 2 2 2 1 1 1 1 1 1 1 1 2 2 0 1 1 1 1 1 2 2 2 2 2 2 2 2	Flipped Triad fpin24 BCg H fp_smm3=2FH	Not Flipped Triad fpin23 BCg H fp_smm2=2CH	Rt Wt Ht	0 0 -1 -1 -1 -1 -2 -1 1 0 1 -1 1 -1 1 -1 0 1 7	[3, 2, 4], (1, 3, 7), (1, 5, 4), (2, 3, 5), (2, 7, 4), (3, 6, 4), (5, 6, 7) [2, 3, 6], (2, 4, 5), (3, 6, 5), (4, 6, 7)]	[1, 2, 6, 3, 7, 4, 5] [1, 2, 6, 3, 7, 4, 5] [0, 1, 1, 0, 0, 1, 0]
234	$\frac{-1/3}{r L}$		{BCR, E7, E6, H14, sub24, abSub24, snub24H14, 24ceH14}	Oppgssse 01001010 ₂	Ba1 E81 W1 Ph1	1 1 1 1 1 0 0 1 1 1 1 1 1 1 1 1 2 2 2 2 2 2 2 2 1 1 1 1 1 1 1 1 2 2 0 1 1 1 1 1 2 2 2 2 2 2 2 2	Flipped Triad fpin7 BCg H fp_smm3=63H	Not Flipped Triad fpin1 BCg H fp_smm3=63H	Rt Wt Ht	0 0 -1 -2 -1 -1 -2 -1 1 0 1 0 -1 -1 1 0 0 1 8	[1, 4, 2], (1, 5, 3), (1, 6, 7), (2, 3, 5), (2, 5, 7), (3, 7, 4), (4, 6, 7) [2, 3, 6], (2, 4, 5), (3, 5, 4), (3, 7, 4, 5, 6, 7)]	[1, 2, 4, 3, 5, 6, 7] [1, 2, 4, 3, 5, 6, 7] [1, 1, 0, 0, 0, 1, 1]

Seq #	Symbol	2D/3D Shape	Groups	Particle Quantum Bits	Binary / E8 / Physics Coordinates	Algebra Root Weight / Height / Rftr Atomic Element Number -->	Ele #	Octonions	
248	$E_{x_2} \begin{smallmatrix} 0 \\ \sqrt{2} \\ -2 \\ R \end{smallmatrix}$		{8Ortho}	0p9gssec 001001100 ₂	Ba[1 1 1 1 1 1 1 1 0] ES[1 0 0 0 0 0 0 0 0] Ph[1 0 0 0 0 0 0 0 0]	Rf(1 1 1 1 0 1 1 1) Wf(1 0 0 0 0 1 0 0) Ht 6	Exc 1	Flipped Invalid octonion Fano plane not defined! Invalid octonion Fano plane not defined!	Not Flipped Invalid octonion Fano plane not defined! Invalid octonion Fano plane not defined!
249	$E_{x_2} \begin{smallmatrix} 0 \\ \sqrt{2} \\ -2 \\ L \end{smallmatrix}$		{8Ortho}	0p9gssec 001001100 ₂	Ba[1 1 1 1 1 1 1 0 1] ES[0 1 0 0 0 0 0 0 0] Ph[0 1 0 0 0 0 0 0 0]	Rf(0 1 1 1 0 1 1 1) Wf(-1 1 0 0 0 1 0 0) Ht 5	Exc 1	Flipped Invalid octonion Fano plane not defined! Invalid octonion Fano plane not defined!	Not Flipped Invalid octonion Fano plane not defined! Invalid octonion Fano plane not defined!
250	$E_{x_2} \begin{smallmatrix} 0 \\ \sqrt{2} \\ -2 \\ R \end{smallmatrix}$		{8Ortho}	0p9gssec 001000100 ₂	Ba[1 1 1 1 1 0 1 1 1] ES[0 0 0 1 0 0 0 0 0] Ph[0 0 0 1 1 0 0 0 0]	Rf(0 0 1 1 0 1 1 1) Wf(0 -1 1 0 0 1 0 0) Ht 4	Exc 1	Flipped Invalid octonion Fano plane not defined! Invalid octonion Fano plane not defined!	Not Flipped Invalid octonion Fano plane not defined! Invalid octonion Fano plane not defined!
251	$E_{x_2} \begin{smallmatrix} 0 \\ \sqrt{2} \\ -2 \\ L \end{smallmatrix}$		{8Ortho}	0p9gssec 001000000 ₂	Ba[1 1 1 1 0 1 1 1 1] ES[0 0 0 1 0 0 0 0 0] Ph[0 0 0 1 0 0 0 0 0]	Rf(0 0 0 1 0 1 1 1) Wf(0 0 -1 1 1 1 0 0) Ht 3	Exc 1	Flipped Invalid octonion Fano plane not defined! Invalid octonion Fano plane not defined!	Not Flipped Invalid octonion Fano plane not defined! Invalid octonion Fano plane not defined!
252	$E_{x_2} \begin{smallmatrix} 0 \\ \sqrt{2} \\ -2 \\ R \end{smallmatrix}$		{8Ortho}	0p9gssec 000001100 ₂	Ba[1 1 1 0 1 1 1 1 1] ES[0 0 0 0 0 1 0 0 0] Ph[0 0 0 0 0 1 0 0 0]	Rf(0 0 0 0 0 1 1 1) Wf(0 0 0 0 -1 1 0 0) Ht 2	Exc 1	Flipped Invalid octonion Fano plane not defined! Invalid octonion Fano plane not defined!	Not Flipped Invalid octonion Fano plane not defined! Invalid octonion Fano plane not defined!
253	$E_{x_2} \begin{smallmatrix} 0 \\ \sqrt{2} \\ -2 \\ L \end{smallmatrix}$		{8Ortho}	0p9gssec 000001000 ₂	Ba[1 1 1 0 1 1 1 1 1] ES[0 0 0 0 0 0 1 0 0] Ph[0 0 0 0 0 0 1 1 1]	Rf(0 0 0 0 0 0 1 1) Wf(0 0 0 0 0 1 1 -1) Ht 1	Exc 1	Flipped Invalid octonion Fano plane not defined! Invalid octonion Fano plane not defined!	Not Flipped Invalid octonion Fano plane not defined! Invalid octonion Fano plane not defined!
254	$E_{x_2} \begin{smallmatrix} 0 \\ \sqrt{2} \\ -2 \\ R \end{smallmatrix}$		{8Ortho}	0p9gssec 000000100 ₂	Ba[1 0 0 1 1 1 1 1 1] ES[0 0 0 0 0 0 0 1 0] Ph[0 0 0 0 0 0 1 1 1]	Rf(0 0 0 0 0 0 1 1) Wf(0 0 0 0 0 1 1 -1) Ht 0	Exc 1	Flipped Invalid octonion Fano plane not defined! Invalid octonion Fano plane not defined!	Not Flipped Invalid octonion Fano plane not defined! Invalid octonion Fano plane not defined!
255	$E_{x_2} \begin{smallmatrix} 0 \\ \sqrt{2} \\ -2 \\ L \end{smallmatrix}$		{8Ortho}	0p9gssec 000000000 ₂	Ba[0 0 1 1 1 1 1 1 1] ES[0 0 0 0 0 0 0 0 1] Ph[0 0 0 0 0 0 1 0 1]	Rf(-1 -2 -3 -4 -2 7 -5 5) Wf(0 0 0 0 0 1 0 0) Ht 23	Exc 1	Flipped Invalid octonion Fano plane not defined! Invalid octonion Fano plane not defined!	Not Flipped Invalid octonion Fano plane not defined! Invalid octonion Fano plane not defined!

pascalRow#9

Seq #	Symbol	2D/3D Shape	Groups	Particle Quantum Bits	Binary / E8 / Physics Coordinates	Algebra Root Weight / Height / Rftr Atomic Element Number -->	Ele #	Octonions	
256	$\frac{1}{\sqrt{2}} \begin{smallmatrix} 0 \\ \sqrt{2} \\ 1 \\ R \end{smallmatrix}$		{BC8, E7, E6, E5, E4, H4, snub24, ah5Snub24, snub24E8, 24cIII4, Hamming, Idempot}	0p9gssec 01010100 ₂	Ba[1 1 1 1 1 1 1 1 1] ES[1 1 1 1 1 1 1 1 1] Ph[2 2 2 2 2 2 2 2 2]	Rf(0 0 0 0 0 -1 0 0 0) Wf(0 0 0 0 0 -2 1 0 0) Ht 1	Exc 4	Flipped Triad fp1=4 BC8 @ fp_smc3=64H (1, 2, 3), (1, 4, 6), (1, 7, 5), (2, 4, 7), (2, 5, 6), (3, 5, 4), (3, 7, 6), (2, 5, 7), (3, 7, 4), (4, 6, 5)	Not Flipped Triad fp1=7 BC8 @ fp_smc3=64H (1, 2, 4), (1, 3, 5), (1, 7, 6), (2, 4, 7), (2, 5, 6), (3, 5, 4), (3, 7, 4), (4, 6, 5), (0, 0, 1, 0, 0, 1, 1)

